

GLOBAL TV . . . Promising Newcomer to Canadian Television

Broadcast equipment designed today for the day after tomorrow.

# BEFORE YOU BUY A NEW VTR, LOOK AT A REALLY NEW VTR.

**RCA's new technology TR-600 proves medium price and small size can add up to unsurpassed performance. Check the specs — check the price — and you'll discover that the newest offers you the most.**

It's about half the size of standard quad VTR's. With built-in automatics that

used to cost you extra and the latest technology incorporated in a design that gives you superb picture performance.

For example, computer designed and tested modules give superior reliability; unique straight line threading; LED diagnostic indicators flash warnings before malfunctions get out of hand. and its new integrated design cuts active electronic devices by 45%.

Check with your RCA representative. He's got the total value story on the one VTR that's really new.



## RCA



Page 6

**Canada's Global TV Moves Ahead  
(Cover Story)**

The momentum is upward for this independent program service covering southern Ontario. Competitive programming, a dedicated staff and a full complement of RCA equipment are among the contributing factors.



Page 14

**A View of the Winter Games from TV Central**

Olympic honors go to Austria's TV service, Oesterreichischer Rundfunk. As host broadcaster, this organization supplied outstanding technical facilities to help bring the snowy spectacle in Innsbruck to a worldwide audience.

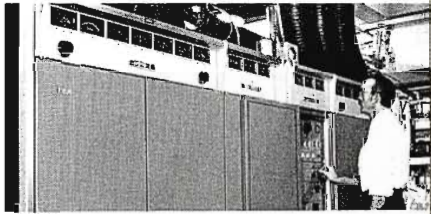

Page 20

**KNTV Installs Twin RCA Transmitters with  
Dual Digital Remote Control System**

New solid state transmitters with computerized remote control move this San Jose station into an efficient Alternate Main operation, with improved color performance and a strong, clean signal throughout the coverage area.



Page 25

**Sears Expands Its Communicating Skills with Corporate TV**

The nation's largest retailer uses "show-biz" techniques to keep its comprehensive TV production center busy with assignments from "clients" in merchandising, marketing, catalog, training, management information, public relations and personnel.



Page 31

**Quaker Takes TK-630 Cameras On The Road**

This Visual Communications staff effectively serves 30 separate divisions and departments, keeping two TK-630 color cameras on the move, covering studio and location assignments.

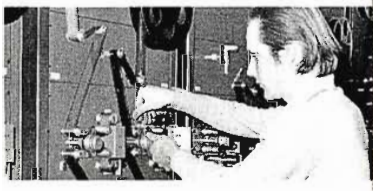

Page 34

**The Burbank Studio (TBS) Adds a Re-recording Stage**

A "total concept" production center enlarges its creative environment for motion pictures and television with a new sound re-recording complex.

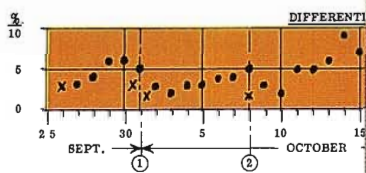

Page 40

**Unattended UHF Transmitter Operation Tested at WNJT-TV**

A Broadcast Systems staff engineer discusses a 39-day experimental "hands off" simulation of unattended UHF-TV transmitter operation—a joint effort of RCA and the New Jersey Public Broadcasting Authority.

# View Finder

## RCA NAB Exhibit Shows Something New For Everyone

RCA rolled a newly created TV mini-van into its NAB exhibit, parked it adjacent to its studio set, and originated—from the van—a sparkling demonstration of the RCA camera line.

The van, less than 19' long, is a fully equipped mobile unit with a complement of two TKP-45 cameras, a TR-600 quad recorder with built-in time code generator, an audio mixer, a video switcher, a special effects generator, and full monitoring facilities. A highly visible result of RCA development and product improvement programs, the van quickly became a premiere attraction of NAB.



## The TK-76 Camera Moves Into Electronic Journalism With Handling Ease, Quality Picture, And Moderate Price

NAB was the first opportunity for many persons to see a live demonstration of the TK-76 camera, designed for service where quality EJ is desired. A TK-76 moved about the camera studio, powered from a 12 volt battery belt, ably capturing a most usable picture.

The video signal from the TK-76 was directed to a short range microwave transmitter located at the corner of the set, relayed to a microwave receiver atop the mobile van, then to an RCA video synchronizer . . . a signal path simulating typical EJ activity.

In the live demonstration, and on tapes produced of nearby Chicago action, the TK-76 held its firm position as a quality, moderately priced EJ camera unit offering the economy of video with the "feel" and handling qualities of a film camera.

More than 175 TK-76 cameras have been ordered.



Enthusiastic NAB audiences saw the new self-contained TK-76 portable color camera, top photo, designed for quality EJ, produce excellent pictures at the same time it handled like a film camera. The new TK-46 studio camera and a TKP-45 portable, configured to operate from a battery-powered "Minipack" CCU, captured the "Candy Store" action with pictures of great realism and color fidelity.



Studio demonstrations were run by RCA staffers from the compact mini-van mobile unit which was fully equipped with a TR-600 quad, audio and video control, and switching.

Bob Hurst and Art Banks discuss how the new RCA Digital Video Synchronizer, used "live" throughout the NAB studio demonstrations, automatically locks all incoming video signals to the "station" sync.

The Video V character generator shows capability as a new and advanced graphics system.

In the lower picture, a moderate price, high capability Automatic Time Code Editing System is introduced as an integral accessory to the TR-600 recorder. Models were shown of both local and remote control systems.



### TK-46 Is Introduced As A Studio Camera Without Peer

The RCA NAB camera studio, outfitted in the manner of "The Penny Candy Store", obviously duplicated the real world of studio telecasting. The newly introduced TK-46, with advanced pre-amp design, tiltable viewfinder, and a host of other features moved through a series of events showing super-quiet pictures and reproducing the peppermint sticks, jelly beans, soda glasses and chrome with perfect realism and color fidelity. The obvious conclusion to be drawn from its work—TK-46 clearly is in a class of its own . . . a worthy successor to its TK-45 and TK-44 predecessors.

### TKP-45 Is Demonstrated As A Completely Independent Portable With Minipack CCU

Also a first time demo for many persons, the top-of-the-line TKP-45 was seen throughout NAB camera presentations operating from a DC-powered Minipack CCU. The ability of TKP-45, the "teleproduction portable", to operate free of common power sources reinforced its value as a one-camera camera system.

The "Minipack" CCU can operate either from rechargeable nickel-cadmium battery packs (which can be changed in less than a minute) or from an AC power adapter which may be substituted for the battery pack.



### AE-600 Automatic Time Code Editing Becomes An Integral Accessory To The TR-600 Recorder

Large scale integrated circuitry, advanced microprocessor and programmable memory devices are the basics from which AE-600 Automatic Editing has been developed. Created for the first time in a VTR, keyboard data entry; for the first time in a VTR, a built-in microprocessor; for the first



Glenn Romsos, engineering director of WKBS-TV (right), and Bob Winn use NAB to discuss the possible saving in electrical energy with use of RCA's anode pulser for UHF video transmitters.

(Opposite page) Lee Hedlund, RCA project engineer, loads the video optical recorder with capability for storage and instant retrieval of 10,000 TV pictures. The recording technique uses lasers to record in a system controlled by mini-computer. The laboratory-built unit was demonstrated for the first time at NAB.



time in a VTR, a time code generator built on one electronic module.

The ability of TR-600 to handle tape edits quickly, efficiently, and with a great deal of technical finesse is a hallmark of AE-600 automatic operation. Increasingly apparent with each shuttle of a tape was the editing creativity which could evolve from the AE-600 features which raise it high in the company of "intelligent" equipment.

AE-600 is being offered in systems for local and for remote control. In either configuration, the AE-600 electronics are housed within the TR-600 chassis. Systems may be configured to remotely control a Record TR-600, up to eight playback TR-600's and three external devices.

### Warner Cable Orders First Half-Speed TR-600 VTR's

Warner Cable Co., New York, will install the first RCA TR-600 video tape recorders to be modified for half-speed operation (7½ ips).

The four modified tape machines will permit the cable company to record twice the usual amount of TV information on a tape reel and to play back without interruption full feature programs for pay TV subscribers.

Half-speed operation of quadruplex recorders—with the promise of a 50 percent savings in tape costs—has been possible for some years, but with a consequent loss in signal-to-noise performance which many users found unacceptable.

RCA engineers developed, and demonstrated at trade meetings, a new super highband accessory which provides essentially the same picture quality at half-speed as achieved with full speed highband operation. The machines purchased by Warner Cable represent the first commercial application of the new equipment.

Warner operates 135 cable TV systems around the country and serves more than 532,000 subscribers. It will use the RCA recorders to originate programs for cable systems in Bakersfield, Calif.; in Canton-North Canton, Ohio, including a microwave link to Akron, and in Fort Walton Beach, Fla.

The fourth machine will be installed at Goldmark Communications, Stamford, Conn., where it will be used to dub feature motion pictures to the 7½ ips tape format and to build a tape library for future production of film cassettes.

The super highband accessory cable installed in the TR-600 at the factory or in the field includes a new 6 mil headwheel tip. Once modified, the TR-600 can be switched between standard and half-speed modes of operation.

### Louisiana Educational TV Network To Expand Operations With New RCA Transmitting System

The Louisiana Educational TV Authority has ordered a 25-kilowatt RCA TV transmitting system, valued at more than \$560,000 to provide educational

and cultural programming to viewers in the northeast section of the state.

The TT-25FH highband VHF transmitter and custom-built antenna system will be installed in Monroe, La., and will produce 316,000 watts of effective radiated power on Channel 13, according to Billy Porter, chief engineer for the Authority.

"The Monroe station is the second in our planned statewide network aimed at providing educational TV coverage to all major population centers of the state," Mr. Porter said. The Authority's flagship station broadcasts from Baton Rouge, La.

Louisiana educational TV carries programs of PBS and SECA and supplements them with locally-produced programming of special interest to its viewing audience.

### American Forces Network Prepares For Full-Color TV Broadcasts In Germany With RCA Studio Equipment

U.S. military personnel and their families in West Germany will be able to receive full-color TV programs originated by an RCA television studio system which is being installed in a new TV production and broadcast center in Frankfurt.

Officials of the American Forces Radio and Television Network-Europe, which will begin using the RCA system late this year, visited RCA recently to observe final testing of the new system.



Bernard Brink, foreground, systems engineer for the Television-Audio Support Agency, and RCA's Herb Dover check out operating features for American Forces Network studio system which will bring color programs to U. S. military personnel in Germany.

Robert S. Murch, Chief, Television Engineering for the American Forces Network in Germany, said the studio system is composed of three TK-45 "live" color cameras; two TK-28 systems for originating color film shows, and switching and audio equipment.

"Programs originating in the new Frankfurt center will be beamed to viewers via existing microwave links to more than 100 low-power transmitters located throughout the country, Mr. Murch said. "Most of these transmitters are under ten watts of output power to confine the signals generally to American forces locations."

Bernard Brink, Systems Engineer for the Television-Audio Support Agency, Sacramento Army Depot, which is responsible for equipping military-run broadcast facilities around the world, said the new Frankfurt center will operate on the NTSC, 525-line, television standard.

"We are moving toward adopting the U.S. standard in our broadcast operations worldwide," Mr. Brink said, "so that service personnel can use their U.S.-built TV sets wherever they are assigned."

AFN TV-Germany currently operates on a 12-hour broadcast day beginning at noon during the week. On weekends, the network televises shows up to 18 hours a day.

"We program a wide variety of shows throughout the day, including popular shows from the U.S., feature films, afternoon "soap operas," and children's shows," Mr. Murch said.

Most sports broadcasts are delayed due to the logistics of transporting video tapes and films to Germany. "Our equipment does have the capability to handle remote satellite feeds, however, and some major sporting events are carried live," Mr. Murch said.

Although a non-commercial network, AFN does have its own form of "commercials." Many 'command information' programs designed to keep service personnel informed are televised, including host-government regulations, tips on travel, and other 'public service' announcements.

"When our new studio becomes operational, we'll be able to produce locally more programs of specific interest to Americans serving in West Germany. Also, our viewers will be watching consistently good-quality color pictures, the kind they are used to back home in the States," Mr. Murch noted.

### WNAC-TV Adds Eight RCA TV Cameras To Meet Increased Production Requirements

WNAC-TV, Boston, an RKO General station, has ordered eight RCA color TV cameras, valued at more than \$500,000, to meet the demands of increasing studio and on-location production work and for newsgathering.

The order includes five top-of-the-line TK-45A studio cameras, one TKP-45 studio-quality portable, and two TK-76 electronic news portables.

Kenneth McGowan, Chief Engineer for WNAC-TV, said the Channel 7 station has been steadily increasing its penetration of the Boston-area program production market. "We have the technical competence to produce a quality product, and potential customers are recognizing this more and more," Mr. McGowan said.

"The five RCA studio cameras will give us a competitive advantage in in-house production and, with the TKP-45 portable system, we'll be able to do on-location programming and commercials without sacrificing quality," he added.

The TK-76 cameras will be used to increase the station's "on-the-spot" news coverage.

Lad Hlavaty, Vice President, Engineering, for RKO-Television, said that the increase in WNAC-TV's production activity began in 1974 after installation of an RCA TCR-100 video tape cartridge recorder. "We're using RCA 'cart' machines at three of our stations to automate breaks—for on-air playback of commercials, station identifications, program promotions and other short taped segments," Mr. Hlavaty said.

"The cartridge recorders have simplified our studio operations and freed existing reel-to-reel video tape recorders for other work. We're now putting those recorders to good use in the production field," he added. □

# GLOBAL TV IS GOING PLACES

On January 6, 1974, a new independent Canadian program service—Global TV—was launched. Two months later it was nearly insolvent. But today it's a vibrant and viable operation brought about by new ownership, a refinancing plan, highly competitive program schedules, aggressive marketing and dedication of employees at all levels.

These are pithy facts, and behind them lies a bittersweet story. A story that is perhaps unique in the annals of TV broadcasting, but certainly a successful one in spite of its rather shaky beginning.

Although the financial horizon clouded up before the young network was fully under way, there was always a clear vision of Global's basic purpose: to serve a potential viewing audience of 7 million in Southern Ontario—from Windsor in the south to Ottawa in the north.

Technically, there has been no fundamental change in meeting that objective. An unusual transmitting grid and a full complement of RCA equipment are still used to illuminate the TV screens of Global's huge audience. The major difference lies in what they're now watching, and how Global goes about providing it.

## In the Beginning

Global's new glow is traceable to a gleam in the eye of original founder, Al Bruner. Eight years ago, he conceived the idea of a third Canadian network. Primary rationale was to build a more balanced national broadcasting system. However, a major factor in obtaining the license was a commitment to develop programs through independent Canadian producers to vitalize the country's production industry.

Enthusiasm and support grew. So Bruner established Global Communications Limited and went about implementing his ambitious plan.

A former steel fabricating plant close to downtown Toronto was purchased and transformed into a handsome and functional broadcast facility called Global Center. This was accomplished with the aid of Imagineering Limited, a consulting company that provided a broadcast-integrated design; and architect Raymond Moriyama who interpreted the interior landscape in contemporary terms.

The central equipment room and four shootings areas are on the ground floor. There are two medium-sized studios (50 x 70 ft and 40 x 60 ft), a production booth (18 x 24 ft) and the newsroom studio. The largest studio, for major program and commercial production, was designed to work out of Control Room 1 which is in the process of completion. In the interim, it shares Control Room 2, or is operated from Global's new mobile production van. The production booth and newsroom studio operate out of Control Room 3.

## Hardware, As It Is

To make the technical facilities as modern as the state of the art, an impressive array of equipment was purchased through RCA Limited in Ste Anne-de-Bellevue, Canada: 14 TK-45 cameras, 7 TR-70C's, 3 TK-28 film islands, a TCR-100 cartridge tape recorder, 3 VHF transmitters and 6 antenna systems. To all of this was recently added RCA's Video IV graphics system.

The decision to select RCA as the equipment supplier was based on a number of considerations, the major ones being that: no other supplier could furnish everything Global needed as one package; the design philosophy of the equipment is similar; and follow-up service is provided by a single source.

Global's new broadcast TV van covers a full schedule of remote programming. Among the custom-installed equipment are six TK-45 cameras and two TR-70C VTR's, one of which is shown below. Fully geared for color production, the 42-ft mobile unit provides outstanding coverage of remotes such as a 90-minute color special (far right) and weekly WHA ice hockey games.





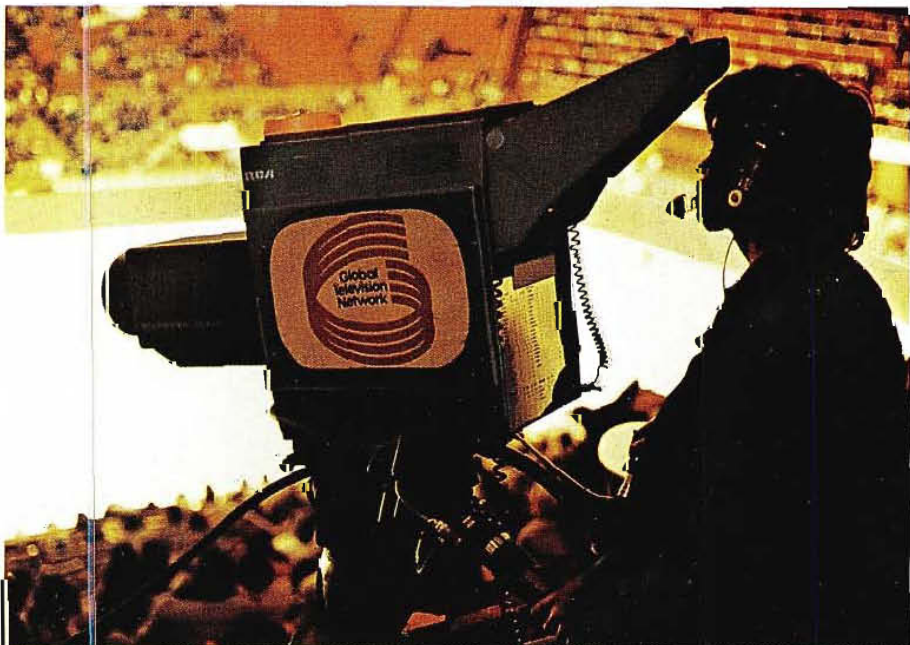

### **Software, As It Was**

For programming, the original management launched 25 new shows simultaneously, all very elaborate and produced by independent Canadian producers. This, the critics say, is what put a big glitch in Global's financial picture. Not only were they expensive to produce, but audience support was slow to develop for most of them.

The shows met the regulatory agency's requirement that 60% of total air time contain programming Canadian in content and character. Unfortunately, more was spent on production than was brought in through time sales.

### **Practical Planning**

All too aware of what this meant to Global's future, the new management quickly set about coming up with some creative solutions.

They first considered "fixed" costs. Equipment facilities were already installed and needed. Foreign programming was necessary to help attract audience and advertisers alike, thus subsidizing in-plant productions.

Independent production was the only area that afforded any cutbacks. So they excised the original programs that generated no revenue (which was most of them); reprogrammed with audience-building shows largely American; placed major production emphasis on news and public affairs; and filled wide gaps with relatively economical, high quality popular remotes.

It worked. The company's new president, dynamic and energetic J. Allan Slaight, asserts that, "Global has turned into a good business investment, with good advertiser acceptance and good ratings."

One bellwether of its success is a diversity of remote programming.

### **A Road to Success**

The new 42-ft mobile van makes good economic sense. Remote coverage helps keep production costs down, while contributing to the Canadian content requirement and satisfying viewers' interests.

Another example of sound planning is the choice of a semi-trailer type of vehicle. Transport is taken care of by a rented tractor, thus reducing cost of possession.

Custom designed by Global's technical staff, and outfitted with RCA equipment, the studio-on-wheels is designed with teleproduction in mind. It has six permanently assigned TK-45 color cameras; two TR-70C's which are borrowed from Global Center as the need arises; plus all new solid-state switching, complete audio mixing, audio tape playback and color monitors.

Since the van was completed last June, remote assignments are running the gamut: ice hockey, variety shows, concerts, golf tournaments, lottery drawings and political conventions. With that kind of schedule, the unit is on the road at least once a week.

### **Quality, Inside and Out**

The cameras are ideally suited to the vagaries of lighting which field conditions present. According to Ron Hutcheon, Manager of Engineering, excellent picture quality is easy to achieve with features such as high sensitivity and automatic iris. A case in point is Global's weekly coverage of the season's WHA ice hockey games from Toronto's Maple Leaf Gardens.

The van's six cameras are deployed at ice level, in the middle and upper reaches of the stands, in an overhead gondola and in a studio.

"Despite the difference in light levels on the ice and in the stands," Hutcheon says, "the TK-45's sensitivity has allowed pictures of uniform and consistently high quality for every game."

Another camera feature employed at the games is Scene Contrast Compression. Sometimes there is very severe contrast between highlights and shadows for a particular crowd shot. The TK-45 lifts details from the shadows without affecting the highlight areas.

He cites still another helpful feature, on location or in the studio. And that's the camera's selectable channels at the viewfinder, which many cameras don't have. In troubleshooting, the camera head can be checked out quickly. To see if the color channels are leaving the camera, the cameraman has only to punch each channel button.

The quality output of the camera is further demonstrated in the distinctive video emanating from Global Center.

An afternoon game show, *Horoscope Fortune*, is a good example of how the camera's automatic operating features help maintain quality, while permitting creative people to make decisions with complete freedom.

The set consists of a low-lit background and full-lit foreground for the host. Directions for two cameras include close-ups of decorative details on the backdrop. As the cameras alternate, auto iris responds instantly to the lighting change while sustaining full video level.

In the newscasts, a dramatic effect is achieved by chroma keying the talking head over a black background. The wall behind the main newsdesk is painted a flat ultra-marine blue to provide the backdrop for keying.

Lending themselves to chroma keying isn't the only way the two TK-45's used in the newsroom help achieve the desired look. Another contributing factor is their stability in blacks, and excellent resolution and noise.

### **News is News**

The newsroom-studio and the adjacent production booth work off of Control Room 3 into which three TK-45's are tied. One of the cameras is shuttled back and forth so both studios always operate with two.

Another TK-45 and a TK-28 film island are located in the Ottawa studio in the National Press Building across the street from Parliament Hill. It's a self-contained unit that also has the capacity to process and edit film.

Using 24-hour microwave link ties with the Toronto studios, Global can get live and/or filmed political news segments on the air fast.

Ratings and acceptance of Global's newscasts have grown substantially, which is especially gratifying since such audience loyalty usually takes years to establish.

According to a recent Nielsen, the early evening news was first in adult audience among all Toronto, Buffalo and Hamilton stations.

Commenting on the growing popularity of the newscasts, Executive News Producer Ken Mallett adds: "Global's news presentation has style. Our anchor-men in Toronto and Ottawa are top-



Since its installation two years ago, the TCR-100 has logged about a quarter-million plays.



The library of current cartridges, 1300 of them, reflects Global's heavy tape load. Office-furniture files provide instant access.



Three of seven TR-70C's are reserved for major editing work. Global has parlayed a built-in VTR advantage into an economical, home-grown editing technique allowing consistent edits within a quarter second of that obtained with expensive edit controllers.

flight journalists, not just readers. They write a lot of the stories themselves, and are encouraged to give personal but responsible comments in their piece to camera."

Global has invested heavily in this area of programming. Slight says, "We've made a great commitment to news." He feels that the news operation establishes the identity of a TV operation and sets it apart from the competition. So the investment is worthwhile, especially in view of the fact that news is considered Canadian content. Interestingly, it has been expanded from four hours per week to about 16 hours in spite of a million-dollar budget cut.

#### Production with Flexibility

Extending the capability of the news room and other studios are the tape and telecine areas. An interesting aspect of these facilities is that they were built with future expansion in mind. When the layout was being designed, the consensus was to provide more space than originally needed, rather than make costly modifications at some future date. Also significant is that tape and telecine are built as an independent operating unit with its own air conditioning and humidity control system.

Four separate rooms along an L-shaped corridor house all tape operations. This affords a degree of isolation from other machines and traffic so the VTR operators are free to concentrate on the job at hand. Furthermore, although each room can be reached by a house paging system, large, circular windows on the corridor walls allow visual communications.

One room contains two TR-70's for on-air playback. Two more in another room are committed to recording. These occasionally are pressed into service for editing, a straight dub-over process for news features from an incoming feed.

#### Editing, Global Style

The third room has three TR-70's. Although used for recording and delayed broadcast, these VTR's are reserved chiefly for important editing.

It consists of assembling programs from separate sources, and is accomplished by the staff's ingenuity in utilizing a built-in advantage of the TR-70. The net result is an insert of pre-programmed duration which comes out on the money every time.

The staff has developed its own editing

technique which permits something beyond the manual control of the machine's electronic splice capability. At a very modest cost, Global engineers altered the two Auto Stop circuit boards so that they perform an Edit Control function.

To achieve an insert of prescribed time duration, cue marks are recorded on the new master tape by using the Cue Mark facility of the TR-70. The modified Auto Stop circuitry activates the electronic splicer rather than the Control Stop function of the recorder.

The system relies on the operator's reaction time, and knowledge of the pre-roll characteristics of the source. Nevertheless, he can consistently make edits within one-quarter second of that which could be obtained with expensive editing controllers.

One of the saving features of the home-grown procedure is the ability to edit at the same exact point on the master tape if something should go wrong. Inserts of one-second duration are possible if required.

The VTR staffers readily admit this arrangement has its limitations, and that Time Code Editing would allow



Two of the larger studios work off of spacious Control Room 2, displaying output from live, tape and film sources.

(Inset pictures, clockwise from left) Pictured is one of two TK-28 film islands which air feature films and full programs. Separate magnetic sound track capability is included, and may be locked to any of the four TP-66 film projectors.

Busy newsroom studio works off of Control Room 3 and has access to three TK-45's.

Video IV graphics system increases production flexibility. It consists of dual keyboards and remote control units to handle two separate productions simultaneously. Magnetic "floppy" disks for message storage reside in a rack in the Central Equipment Room.

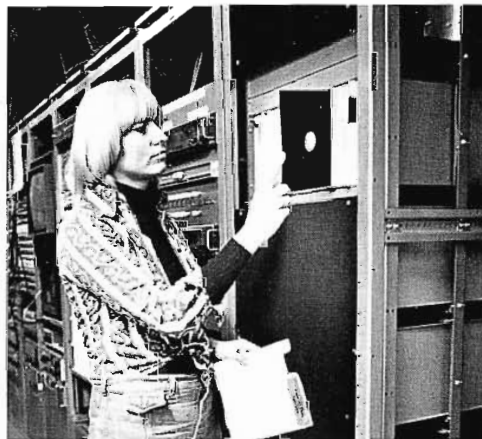

fancier work. However, they can enhance the result of their technique by feeding two of the TR-70's into a switcher and through a dissolver.

Doug Bonar, VTR Supervisor, speaks well of the TR-70's. He likes the picture quality and the stability of the signal, which make the machines favored for editing.

Commenting further, he says that the TR-70's are getting good head life, and the interchangeability of the headwheels and modules is a real convenience.

#### **Cartridge Operations**

Around the corner from the reel-to-reel area is the cartridge tape room. A TCR-100, an independent facility with the Signal Processing Unit (SPU), is dedicated to the automatic handling of commercial blocks, public service announcements, program promos, ID's and bumpers.

Although commercials come in on film and tape they are immediately dubbed to cartridges. This is done in the morning before going on air at 11:30 AM.

Office-file furniture serves nicely for cartridge storage. Several file cases contain almost 1200 cartridges with commercials and over 100 with promos, station ID's and bumpers. Adding a little international flavor to the library are an additional 50 cartridges with commercials in Greek, Italian and Portuguese. These are shown during ethnic programs on Sunday mornings.

In more than two years' operation, the Cart has certainly proved its worth, airing an average of 28 cartridges an hour, 12 hours a day, every day of the year. On that basis, Global's TCR has logged approximately 250,000 plays or cycles so far.

There are no major operating problems to report, which is the kind of reliability a small technical staff welcomes. The maintenance schedule includes only two technicians to a shift for a substantial amount of equipment.

Before the TCR is taken out of service for routine maintenance, it is used to facilitate the TR-70's handling of the breaks with a back-up reel of daily

commercials called the "day tape". In dubbing the Cart sequences to reel, the TCR records a tone on the TR-70 tape so that it doesn't have to be manually recued for playback.

This is accomplished by using a recorded black cartridge between sequences and the Auto Stop feature of the TR-70. An operator in Master Control rolls the TR-70 and cuts away at the end of the last commercial. The TCR runs on through black, stops two seconds before the end of black and is then ready for the next roll.

#### **Creative Telecine**

Adjoining the tape area is a spacious recess in which two TK-28 film chains sit. Each, fitted with two TP-66 16mm film projectors and a TP-7 slide projector, is remotod to Master Control. Separate magnetic sound track capability is included and may be locked to any of the four TP-66 projectors.

The film islands air feature films and full programs. But with the help of a switcher they too extend Global's production capability by providing an extra video source, with special effects if desired. The output can be dissolved from one island to another.

#### **Enter Video IV**

Adding even more production flexibility is the Video IV graphics system. Production Manager Dan McGuire feels it's a particularly attractive video tool because it's not limited to standard alphanumeric titling.

Global's system consists of dual keyboards, remote panels and disk drives—all of which allows Video IV to handle two different applications at the same time.

Sophisticated uses are still in the development and planning stages as the camera-compose unit is still to be added. In the interim, Video IV is being utilized to provide titling for the news and credit crawls for Global-produced shows. These, as well as messages, are stored as pre-programmed material and readily recalled on demand.

One specialized use was keeping track instantaneously of returns for the last provincial election, with a computer doing the tallying.

#### **Developing Interior Space**

Considering such electronic fabrication of programming, the choice of a former steel fabricating plant was fitting mostly in a metaphorical sense. However, Global recognized the potential of the previously dreary-looking building and licked the problems.

Within the framework of the existing interior, the architect created a plush, dramatic layout with a hint of theatrical imagery in selected areas. Yet it's functionally sound, providing an attractive, well-working environment.

The overall design has a visual consistency, and a common environmental goal of promoting communication among the employees. High ceilings exploited with skylights, carpeting and office furniture in bold contrasting colors, hanging banners and greenery everywhere please the eye.

Contemporary chic describes the dynamic decor of the reception area, lavish with color and elegance. The focal point is a large circular desk, complemented with an unusual seating configuration for visitors. A banquette of bright yellow and red sweeps around and against a mirrored wall that doubles everything in sight.

The administrative work areas consist of large open spaces and see-through offices that provide the same feeling.

Another architectural treatment both esthetic and functional is the use of supergraphics, color coordinated to serve as locator aids.

Just as highly refined are the technical and mechanical installations. A factory building to be transformed into the technical headquarters too presented a number of considerations. Since the building was almost twenty years old, the first task was to review completely the existing mechanical and electrical systems. It was discovered that neither would be suited to the needs of a television studio. So both systems were removed and replaced during the construction phase.

#### **Overhead Cable Trays**

Because the equipment is spread around in different areas, a great deal of



Working within the framework of an existing structure—a steel fabricating plant—the architect created a highly refined, sophisticated interior landscape, as evidenced by the sumptuous lobby-reception area.

thought had to be given to the running of technical wiring in the building.

The tape, telecine and on-air control room locations are on the second floor, while the Central Equipment Room and small studio/newsroom operation are on the ground floor. The two large studios and their associated control rooms are also on the ground floor.

It was determined that the technical areas could be served best with a cable tray system originating in the Central Equipment Room and spreading out to handle other technical areas. Gordon Gaetz, Manager of System Design, believes it's also a good answer to any future requirements for pulling cables for new equipment.

Before construction began, a study was carried out to determine the space required for the cable trays between the ground floor and the underside of the existing second-floor steel structure. The air-handling ducting required considerable space under the second floor in many locations. So it became obvious that its exact vertical location had to be altered.

After many discussions among the architects, consultants and the Global staff, it was decided to set the level of the finished second floor at seventeen feet above the ground floor. This allowed the cable trays to be stacked vertically, and a catwalk for personnel to be installed alongside the cable trays.

A total of five two-section cable trays provide separate runs for audio systems high level; audio systems low level; intercom and communication high level; intercom low level; video systems; sync and sync timing; machine control and CCU remote controls; production and routing switcher remote controls; clocks, RF, tally and miscellaneous; telco and telephone.

#### **Floating Studios**

The construction of the studios also was of some concern since a railroad track runs some 75 feet behind the building. Although this is for a low-speed industrial service line, measurements made prior to construction revealed that it introduced low-frequency disturbances of a high-amplitude. This affected the entire building.

For this reason, the studios were built as a box within a box. Construction consists of concrete floor and ceiling with steel support and solid concrete-block walls. Neoprene pads inside the "box" isolate it from the foundation of the main building. The inside slab is separated by neoprene pads from the outside roof slab. A six-inch air space between the inside and outside walls of the two boxes very effectively insulates the inside studio box from the effect of vibrations from the train. It also provides improved acoustics. The noise criteria specification for the large studios is NC-25, and NC-20 for the small studios.

#### **Simultaneous Signal Delivery**

Basic to Global's service is a unique transmitting grid across southern Ontario. It's considered one of the most advanced, automated and sophisticated systems in the world.

There are three UHF transmitters, plus three RCA VHF transmitters and six RCA antenna systems. Regionally located to cover both urban and less dense areas, they are connected by a dedicated microwave system controlled in the Central Equipment Room.

In the event of failure, each transmitter can be received at an adjacent location for re-transmission. The three locations with the largest portion of the network's coverage have emergency power systems. A roving crew takes care of routine maintenance.

This is the first transmitting system of its kind in Canada, and the first to use "very precise frequency offset". For VHF fringe areas, this technique weaves the unwanted signal into the desired one. As a result, performance is improved in the order of five or ten times.

For most stations located in the middle of their markets, fringe areas are not critical. But they are for Global because the whole coverage area is important.

Global designed the grid recognizing that center-city requirements are being met with cable, but also realizing that cable won't get into the less densely populated areas for some time.

From engineering to production to programming, Global has taken an idea-oriented approach in both outlook and practice. What it amounts to is creative planning operations that have taken this new broadcasting organization far, and should make the future a pleasant challenge of hard work and growth. □

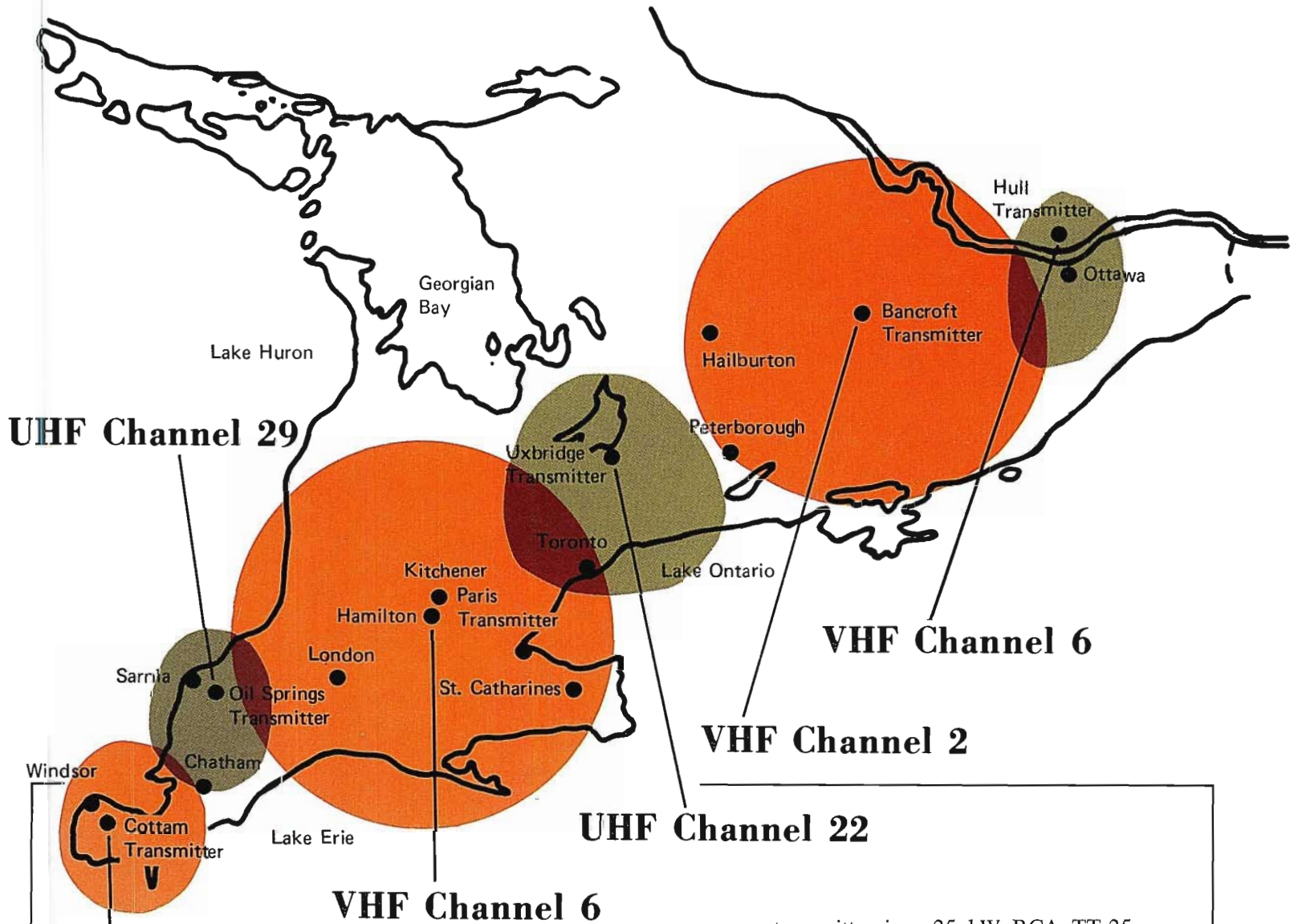

**UHF Channel 22**

**The Global Grid**

**Cottam, UHF Channel 22**

The transmitter and RCA Pylon Omnidirectional antenna (TFU-30JA) provide an effective power of 218,000 watts. Antenna height is almost 400 feet, and serves the Windsor area of southwestern Ontario.

**Oil Springs, UHF Channel 29**

This transmitter beams 370,000 watts from an RCA Pylon Trilobe antenna (TFU-30JDA), about 700 feet tall, toward Sarnia, Chatham and London.

**Paris, VHF Channel 6**

At an elevation of 1000 feet, an RCA Omnidirectional Superturnstile (TF-5CM) on a 951-foot tower transmits at full power—100,000 watts. The

transmitter is a 25 kW RCA TT-25 FL. The signal reaches from the U.S. border to Toronto, and has 3.6 million people in its "B" contour.

**Uxbridge, UHF Channel 22**

This one beams 5,000,000 watts over Toronto and other centers. The directional antenna, an RCA Pylon (TFU-36JDAS), is 1105 feet above sea level on a 470-foot tower.

**Bancroft, VHF Channel 2**

An effective radiated power of 100,000 watts, from the combination of a 15 kW RCA TT-15FL transmitter and an RCA Butterfly Antenna on a 580-foot tower, covers this area.

**Hull, VHF Channel 6**

A 3 kW Multiplexed, IF modulated RCA transmitter (TT3 of Canadian manufacture), and an RCA Dipole Antenna on a 210-foot tower, beam a 12,600 watt signal into Ottawa.



WITH ORF AND RCA





**I**N THE world of sports, no other competition can match the excitement and sheer brilliance of performance in the Olympic Games. In the world of TV broadcast, few assignments come close to matching the enormous logistical and technological requirements for televising the huge spectacle.

At the 1976 Winter Games in Innsbruck, television had a preeminence all its own, providing extensive remote coverage for 12 days and nights for 300 million viewers in the Americas, Europe and Japan.

Host broadcaster was the Austrian Broadcasting Company (Oesterreichischer Rundfunk or ORF) which met the challenge successfully with the active participation of RCA. ORF utilized a large concentration of RCA live and telecine cameras, video-tape recorders and other equipment. And eight RCA engineers from Broadcast Systems in Camden, New Jersey, assisted in setting up the equipment and keeping it in peak operating condition the entire time.

The Austrian TV agency's primary function was to produce a single, continuous "world" program of Olympic events which was made available to all participating broadcasters and broadcast directors — the ABC Network (U.S.), CTV (Canada), NHK (Japan), and the Eurovision and Inter-vision networks.

#### The Game Plan

Preparation for doing so required a long lead time and close, unflagging attention to detail. Three years ago, when it was announced that the '76 Games were to be held in Innsbruck, planning was started by ORF's Technical Department in close cooperation with its Department of Sports. At that stage, the competition calendar for the 1964 Games served as a guideline. Since the competitions, as well as the opening and closing ceremonies, were held in the same locations, it provided a good overview of the production

equipment and personnel that would be needed to mount the enormous undertaking.

On February 15, 1973, a special ORF committee with the following task groups was formed: technical operation, program (radio), program (TV) and commercial and legal activities.

An early conclusion was that the entire transmission could not be handled without additional assistance and equipment. Competitions to be reported were numerous and their locations were geographically far afield.

A program plan compiled by ORF's Sports Department was submitted to and approved by the Olympics Committee in May of 1973. It would provide for broadcast of Olympic programs to a total of 35 TV organizations all over the world. The duration of TV coverage would be an average of eight hours per day. The sportscasts would consist of live telecasts of the men's downhill on the Patscherkofel mountain near Innsbruck; the women's downhill, giant slalom and slalom and men's slalom and giant slalom at Axamer Lizum; the various disciplines of Nordic skiing at Seefeld on the German border some 25 miles west of Innsbruck; speed and figure skating at the Olympic stadia; 90m special jumping

at Berg Isel; plus the bob and luge events at Igls, on the outskirts of Innsbruck.

Three months after submission of the initial broadcast plan, ORF surveyed the entire area where athletes would gather to determine the exact technical requirements. From the papers and reports issued, a final detailed plan for coverage and a centralized equipment operation was put together. It was based on the following technical concepts allowing the most economical use of transmission units.

1. ORF would furnish all of its available mobile vans.
2. As much studio equipment as possible would be transferred from ORF Center in Vienna to Innsbruck.
3. Additional capacity would be met through leasing from suppliers or foreign broadcasters.

The planning departments of ORF then proceeded to develop an equipment list for coverage and production that would satisfy every time and subject requirement during the Games. The events program was sequenced so that there would be no overlap where use of equipment is concerned.

Cross-country skiing, the Biathlon and

Outside IVB Halle, VTR vans and emergency-power mobile units supplemented the equipment within.



Framed against the Tyrolean Alps, the new building of the Innsbruck Public Transportation Authority (IVB Halle) temporarily served as the center for Olympic broadcast programming. As host broadcaster, ORF installed extensive facilities to process and distribute all signals from the competition areas. Pictured below at left is Berg Isel, the site of the opening and closing ceremonies as well as the ski jumping events.



(Top left) One of four production studios for interviews and comments. Each of three studios used a pair of TK-44's. Two more RCA cameras were available on an assignable basis.

(Bottom left) The CCU racks for the TK-44's in the Central Equipment Room.

A studio control room featured an RCA video switcher initially custom built for the TV Center in Vienna.



jumping were covered by three ORF mobile vans with a total of 13 cameras.

Alpine skiing — downhill, slalom and giant slalom for men and women — required only one ORF van with seven cameras. At these events, ORF produced coverage of only the last 50 seconds of each racer's run. ABC covered the beginning portion and recorded the signals in their own mobile van. To make mixing of the signals possible, both vans were operating in PAL standards.

Speed and figure skating competitions at the Ice Stadia were picked up with one mobile unit with five cameras from SRG, Switzerland's TV service.

Bobsled and luge events were reported on by two vans providing nine cameras. These units were leased from ARD and ZDF, Germany's two largest television networks.

At each competition area, there were 20 to 25 TV commentator locations. Facilities consisted of closed, heated booths with windows. They were outfitted with two commentator mikes and two TV monitors. One monitor showed the world program, pictures of the

event occurring at the commentator's location or the transmitted program; the other displayed continuous results from the Olympic computer.

All of the audio lines and video microwave links for these competition sites terminated at ORF's TV Central which utilized \$2.5 million worth of RCA broadcast equipment.

#### From Vienna to Innsbruck

Most of this RCA equipment was drawn from ORF's colossal production center in Vienna, an \$80 million television city for which RCA served as Project Manager from 1968 to 1973. Working closely with ORF Technical and Operations Staff, RCA assumed total responsibility for complete systems design as well as equipment planning, specifications, installation, supervision and testing.

An interesting aspect of the Vienna complex is that it was designed to meet all of the nation's programming needs over a ten year period, a capability well demonstrated by the Austrian broadcaster's outstanding coverage of the '76 Winter Olympics. Also significant is ORF's provision for international

program exchange with the rest of Europe. It is the officially designated interface or connecting point between Eurovision and Intervision which are headquartered in Brussels and Prague, respectively. Experience with the distribution technique facilitated the dissemination of Olympic program material to Britain, Western Europe, Scandinavia and Eastern Europe.

Eight TK-44 color cameras, eight TR-70C video tape recorders, a big video production switcher, a video-tape mixing switcher, a large number of distribution amplifiers and a mobile van with two TR-70C recorders were moved from Vienna to Innsbruck. To round out the complement of RCA equipment, ORF leased two TR-70C's with Time Code Editing and five TK-28 telecine islands. Also part of the overall transmission plan were two TR-70C's in the Raisting Earth Station in Upper Bavaria. They were used for delayed broadcast via satellite for the U.S. and Canada.

#### The Olympic TV Center

All of this plus other equipment contributed to a smooth operation at TV

Telecine operations were handled by five TK-28 film chains. Each included a TP-55 optical multiplexer, a TP-7 35mm slide projector and two TP-66 16mm film projectors individually interlocked with a sep-mag unit for multi-lingual audio playback.

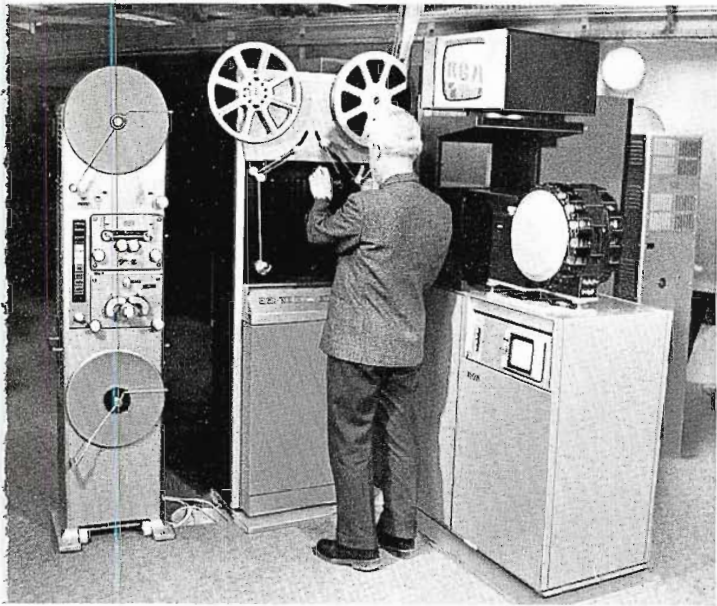

All live and video-tape signals were channeled through ORF's Main Control Room before actual transmission to the world.



Central, the focal point for all the color cameras and mobile units deployed for the gargantuan task.

Regardless of their far-flung destinations, all of the video signals funneled into TV Central for important processing before distribution to a waiting worldwide audience.

From construction to implementation, the TV center was really a remarkable achievement, especially in view of its short-lived use. Equally impressive was the fact that the facilities replicated in large part the elaborate centralized equipment placement and assignment switching system RCA helped develop for ORF's Vienna complex.

At Innsbruck, the production and control center was housed in what eventually will be a trolley garage for the Innsbruck Public Transportation Authority (Der Innsbrucker Verkehrsbedriebe or IVB-Halle).

ORF's TV equipment facilities occupied 47,300 square feet of space in the building. An additional area billeted the central technical operations for CTV and ABC. All of the latter's film

reproduction requirements, incidentally, were handled by TK-27 film islands.

Both broadcasters prepared their own material from the world program ORF provided. However, ABC augmented its selections with pickups from its exclusive cameras in venues of major interest to U.S. viewers. Furthermore, all ABC transmissions were transmitted via ORF's main control room to the satellite ground station in Raisting, and then via satellite to the U.S.

The physical layout of ORF's spacious area in TV Central included the main control room, Eurovision central, video tape operations, the film room, two continuity control rooms, four studios (each with 645 square feet and its own control room), one synchronizing studio, film development and editing, three insert studios, one graphics facility, video maintenance, viewing rooms and other support services.

Outside on the south side of IVB-Halle were four VTR vans and two emergency mobile power units which supplemented the installation inside.

Because of the building's original purpose, modifications were necessary. At

ground level, where the equipment was situated, a removable wooden flooring was installed, over which a felt covering was laid to minimize the effects of vibration and noise caused by personnel.

Again for acoustic reasons, the studios featured "floating" floors. Floors and walls here, and in other critical areas such as the control rooms, were also treated with special sound dampening material.

All partitions were made of plaster-covered panels which were taken down when the Games were over.

When the temporary production center was completed, another immense effort got under way with the opening ceremony at Berg Isel, also the site of the 90m ski jumping competition.

#### Linkages for Global Coverage

ORF's 45 live cameras, which included eight TK-44's in three of four studios, observed and reported the action for 12 days.

Video connections between the competition areas and the TV center were established through ORF microwave

links, 51 in all. The video signals received eventually were switched to the post office which provided eight outgoing lines for further transmission.

- Line 1 To Vienna for ORF (this signal was identical to the world program).
- Line 2 To Munich (via Garmisch in Lower Bavaria) for ARD and ZDF.
- Line 3 To Bozen, South Tyrol in Italy, for RAI, Italy's TV service; or from Bozen to Canada via Germany's Raisting earth station.
- Line 4 To Vienna for transmission upon request.
- Line 5 To Munich for occasional transmissions.
- Line 6 To Albis, a switching point in Switzerland.
- Line 7 For occasional transmissions to Vienna and Albis. Could be switched to Bozen or Munich in cases of emergency.
- Line 8 To Raisting for re-recording to the U.S. (ABC, New York) and Canada (CTV, Toronto).

All of the signals, arriving at TV Central via cable or microwave, came in for some very involved processing. ORF staffers handled subtitle mixing, video tape recording and playback, electronic editing and inserts of film and taped slow-motion segments.

#### **Packaging Programs**

As a result, broadcasters at the Games could select from a variety of inputs for assembly into an interesting product ready for broadcast. The available material consisted of live action at the competition locations and in the studios, video tape from ORF's or the other broadcasters' VTR's, films and slides, plus graphics.

From the standpoint of equipment, the video-tape recorder was one of the key elements for all broadcasters depended heavily on edited video-tape playback of each day's events for their audiences.

If events were spread out on the schedule, video tape allowed broadcasters to ignore unwanted material and thus make better use of their transmission lines.

Time delay was another consideration. The more time difference there was between an event in Innsbruck and the hour it would be shown at home, the more critical the ability to record now and playback later. With a world program on tape, it was relatively easy for each broadcaster to plan in advance the actual content of his own program package.

All told, there were 16 VTR's in ORF's facilities at TV Central, more than what was used for the 1964 Games. Of the twelve RCA TR-70's used, two were equipped with RCA's newly developed super highband format that permits operation at 7.5 ips, half the normal speed, and provides a 50% savings in tape consumption.

#### **Video Source Assignment**

Program assembly by the various broadcasters was further facilitated by ORF's assignment system. The switcher at Innsbruck employed switches using multiple plugs in patch panels. It permitted each video source to be connected with each user module in the appropriate patch panel. Interestingly, an assigned connection could be disconnected only by an inquiry from the control room or upon request.

A red light signal on the patch panel plug avoided accidental separation of on-air connections. Assignment indicators were also used on the VTR and telecine remote control panels. As soon as a user module was connected to a video source, the pertinent lamp lit up at the control panel.

Each VTR had its own switcher and its output was connected to the VTR assignment system. Every TK-28 film island, which consisted of two 16mm film projectors, a TP-7 slide projector and a TP-55 optical multiplexer, was connected to an assignment system with 20 outputs.

The Supervisor Room performed the assigning which involved one video signal and two audio signals from the optical and magnetic tracks, remote start and stop, tallies and intercoms.

#### **Studios and Control**

Four studios accommodated interviews or discussions for use as insert material. Three of them were each equipped with two TK-44's. Two additional TK-44's were available on an assignable basis.

The video control room for Studio 1 was equipped with the 16-input RCA mixer borrowed from ORF's TV theater in Vienna.

Each of the control rooms for the other studios had a six-input mixer with two chroma-key systems, two special-effects generators and one color subtitle keyer.

Lines from the Central Control Area, which handled and assigned remote and studio signals and operated the pulse distribution system, were selected at the Camera Control Table.

It also allowed the camera technicians to adjust camera and film islands.

The control rooms, located next to their respective functions, operated as pure production facilities to complete processing of the competition signals with text, VTR, slow motion and film.

Two control rooms were used exclusively for production of the world program and for completion of signals from the competition areas. On the video side, they were each equipped with a 16-input AB mixer with Y switcher and black fader. The mixer was controlled automatically with a Telex punched tape.

In addition, there were dispatch rooms in which program sequence was selected and supervised for distribution to the EBU (European Broadcasting Union), OIRT (Eastern Europe's International Radio and Television Organization) and ORF.

Switcher output consisted of inputs from the eight outgoing post-office lines mentioned earlier, seven microwave return lines and three outputs of the transmission switcher.

#### **Maintenance**

With such a complex array of equipment filling a wide variety of sophisticated production requirements, maintenance and repair were naturally a part of ORF's overall plan.

A maintenance engineer was stationed at each competition location. Working

out of mobile repair vans, they were equipped to function on their own. However, close contact was maintained with a Maintenance Manager on duty at TV Central if additional help was needed.

ORF also contracted for maintenance and repair with firms who installed or delivered loan equipment. The eight engineers from RCA Broadcast Systems in Camden were available at all times to assist with their specialized knowledge.

**Personnel**

The success of the telecast depended heavily on not only the equipment facilities provided but also on the people who operated and maintained them. Six hundred men and women were required to operate the technical equipment at the competition sites and in the radio and TV Center. The staff consisted of personnel from ORF's Vienna complex, as well as ARD, ZDF and SRG.

Personnel requirements for maintaining continuity of the world program totalled 120. This number also included the necessary staff for producing multi-lateral programs (up to three simultaneously), as well as unilateral programs (four studios at the same time).

**Olympic Epilogue**

ORF is to be congratulated on its successful participation in such a major international event. What's more, because the success of the Games as a broadcast event was so dependent on VTR performance, RCA is very proud that the TR-70 was the basic machine for production of the programming. This included recording of events, editing, dubbing and playback for not only the world program but also for unilateral transmissions totalling 380 hours.

Also impressive is that there was no impairment of ORF's operations during the telecast of the Games.

Norbert Wassiczek, ORF's Technical Director, said: "We were very pleased with the RCA equipment in Innsbruck, as well as the perfect cooperation between ORF and RCA. The RCA staff, with all their experience, helped us tremendously in attaining all our goals." □

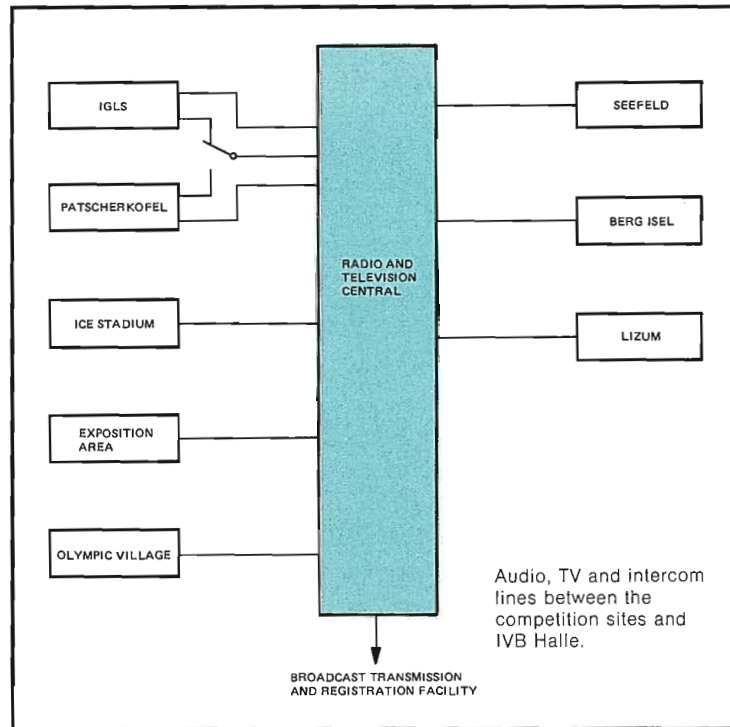

ORF utilized twelve TR-70C's in producing the world program. Four were located in two OB vans. The rest were assigned to four editing suites in which action highlights from many hours of recorded material were quickly assembled. The two machines shown here operated at half speed and were equipped with dual-cue programmer editing systems.

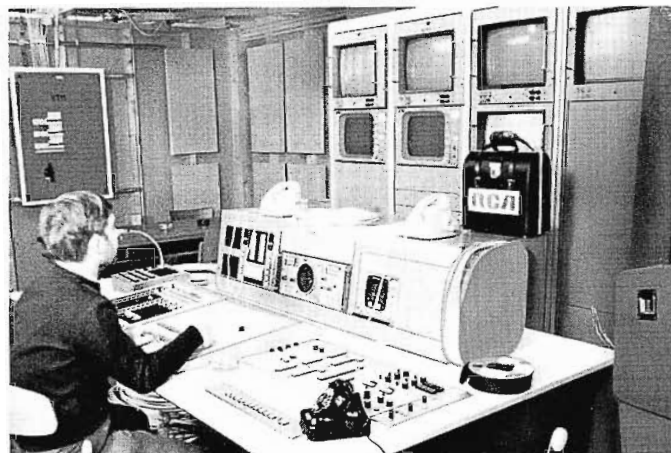

VTR mixing console with full remote control for all machines.

# New Twin Transmitter and Custom Remote Control System Give KNTV a Better Picture

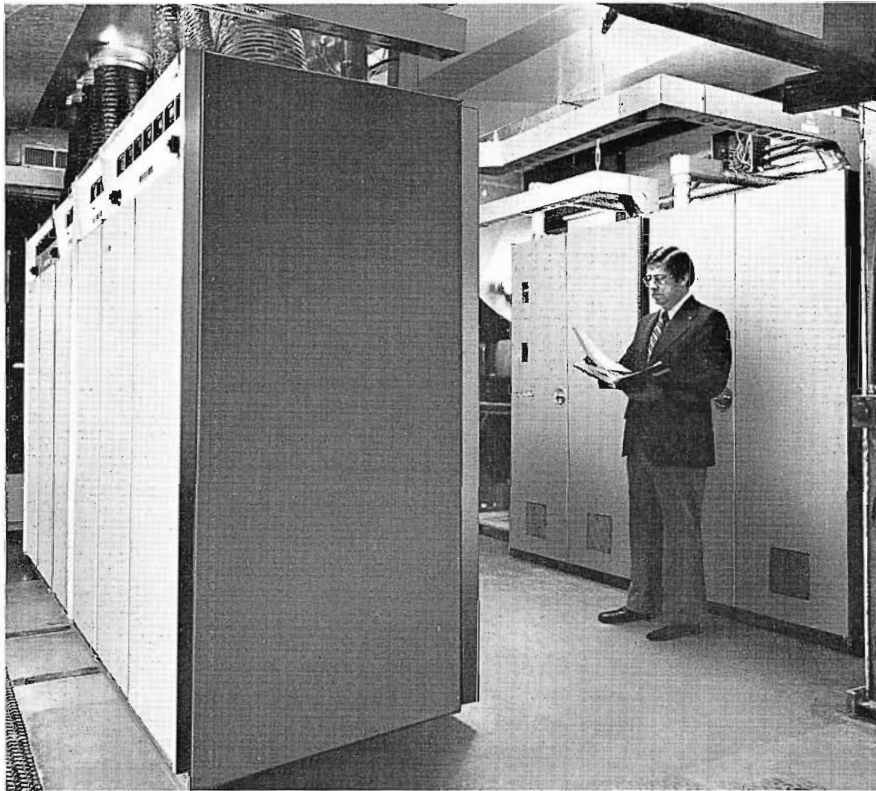

KNTV's two TT-17FH Transmitters are mounted side-by-side and are remote-operated as an Alternate-Main system. Inspecting the installation is Chief Engineer Lou Bell.

Custom TV transmitter remote control system includes numerous design innovations by KNTV engineers. Studio remote control, monitoring and display facilities are checked by Assistant Chief Bob Martin.

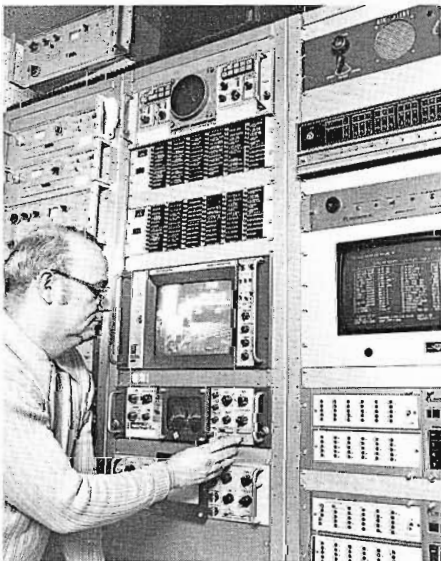

Dual DCS-2 Digital Remote Control Systems are installed. With mini-computer programming, 60 channels of data can be selected for display on CRT video monitor.

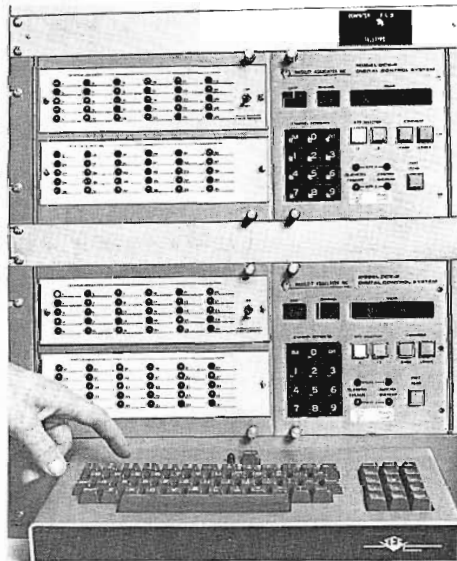

# KNTV

, San Jose, knows what it takes to operate successfully in a tough competitive environment. With its market audience located within reach of San Francisco's Mt. Sutro antenna complex, TV-11 has to compete with the Bay Area's three network-affiliated stations, plus several independent and educational channels.

What it takes, affirms Lou Bell, Chief Engineer for KNTV, is a combination of effective programming; top notch in-house production capabilities, and of providing better service to advertisers and viewers.

### Strong Color Signal Essential

Delivering a strong, clear color signal throughout the coverage area is also essential. KNTV is now operating two new RCA TT-17FH Highband 17 kW transmitters as a Main, Alternate-Main system. The first new transmitter was installed in September of 1973—just in time for the new program season, Mr. Bell notes. One year later, the second TT-17FH was added.

There were several key reasons for investing in new transmitters, according to Mr. Bell. First of all, the old RCA TT-10 which was installed in 1957 had been operated "full bore" for years and was beginning to show its age. Maintenance costs were mounting. In addition, TV-11 was moving into a 24-hour broadcast schedule, which necessitated a back-up transmitter. New solid state transmitter designs offered greatly improved color performance and other operating benefits. And, technological advances made remote control a desirable operating mode.

### Customized Remote Control System

In fact, remote control was thoroughly researched by Mr. Bell and his technical staff long before the transmitter purchase was made. As a result of this in-depth effort, KNTV now operates a customized remote control transmitting system which could well serve as a model for other broadcasters who are planning to operate in this manner.

The KNTV system—in common with most remote controlled transmitter installations at isolated transmitter sites—features extensive redundancy. While back-up protection is becoming increasingly popular in TV transmitter systems

design, at TV-11 the system has gone well beyond normal redundancy.

Recognizing that sophisticated systems involving a large quantity of solid state circuitry and complex logic could be subject to massive outages under unusual circumstances, the KNTV engineers have added a number of system innovations to further protect personnel and equipment.

### Digital System with Mini-Computer

Installed at KNTV is a DCS-2 Digital Remote Control System, complete with a mini-computer. Dual systems, designated as DCS-2A and DCS-2B, are installed at the studio and at the transmitter site. Two telco lines are used for transmitting control and telemetry data. These permit two-way transmission of control signals to the transmitter and metering data to the studio from the transmitter.

For program transmission from the studio to transmitters, dual STL microwave systems are used. These are RCA TVM-6's, with a long history of reliable performance. The audio subcarrier of the microwave system is also used for transmitting control signals from the studio to the transmitter.

Another reason cited by Lou Bell for the dual remote control systems is the requirement that the transmitter must be shut down within 20 seconds after a control signal loss or one hour after a telemetry failure. He insists that it should not be possible for a failure in peripheral equipment in the system (such as remote control system components) to result in taking the transmitter off-air. The redundant remote control system protects against this situation.

### CRT Display of 60 Channels

With computer programming, sixty channels of data can be displayed on a CRT video monitor at the studio control position. A touch-type push-button keyboard is used for calling up the desired "pages" of information for video display.

Status, Control and Metering readings of sixty functions are available on the system. With the "Raise/Lower" capability, this actually amounts to control of 120 functions. Mr. Bell points out. Of these, eighteen can be selected for print-out on the ADP-220 Automatic

Logging System—more than enough to satisfy FCC logging requirements. KNTV has an Auto-Logger at the transmitter location as well as at the studio. All calibration of the remote control system is done at the transmitter site.

### Main-Alternate, Hot Standby

The TV-11 antenna and transmitters are located at Loma Prieta—some fifteen air miles and over thirty long road miles from the studio. Because of its remoteness, the transmitter site will continue to be manned for a period of time according to Mr. Bell, but not for the full broadcast day.

The antenna is a 12-bay RCA Superturnstile which was installed in 1955 when KNTV first went on-air and completely re-built by RCA in 1969. Inside the building, the two TT-17FH Transmitters are lined up, side-by-side, occupying only 11.5 feet of floor space. The TT-10 was dismantled and removed to make room for the new transmitters.

The two transmitters are used on the air alternately, with changeover at one-week intervals. The standby transmitter is automatically connected to the station test load when changeover occurs. Cooling for the test load is turned on automatically when the standby transmitter is started. The system includes one new filterplexer which serves the On-Air transmitter.

The entire transmitter RF output system, including switching system, coax lines, filterplexer and dummy load, was optimized on site for low VSWR. This was done so that after the standby transmitter had been adjusted for good response operating into its dummy load, it then could be switched on-air by remote control, operating through the filterplexer, with no further adjustment and with assurance of good response through the complete system.

### Logic System for RF Switching Sequences

In conjunction with the RF switching system, KNTV engineers designed a control logic system which assures the operator that the automatic transfer functions occur in the proper sequence. The panel readout for this system displays green lights for "OK" condition, and red lights to indicate a fault or "Not Normal" function of the following major transmitting system components:

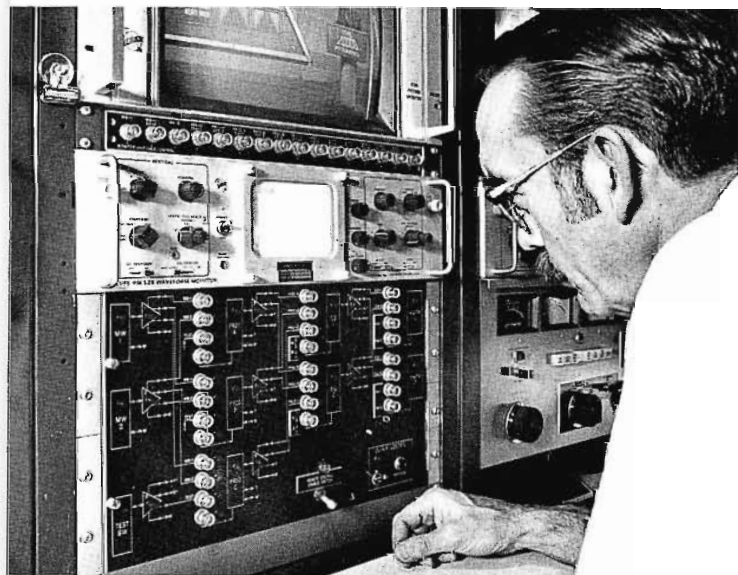
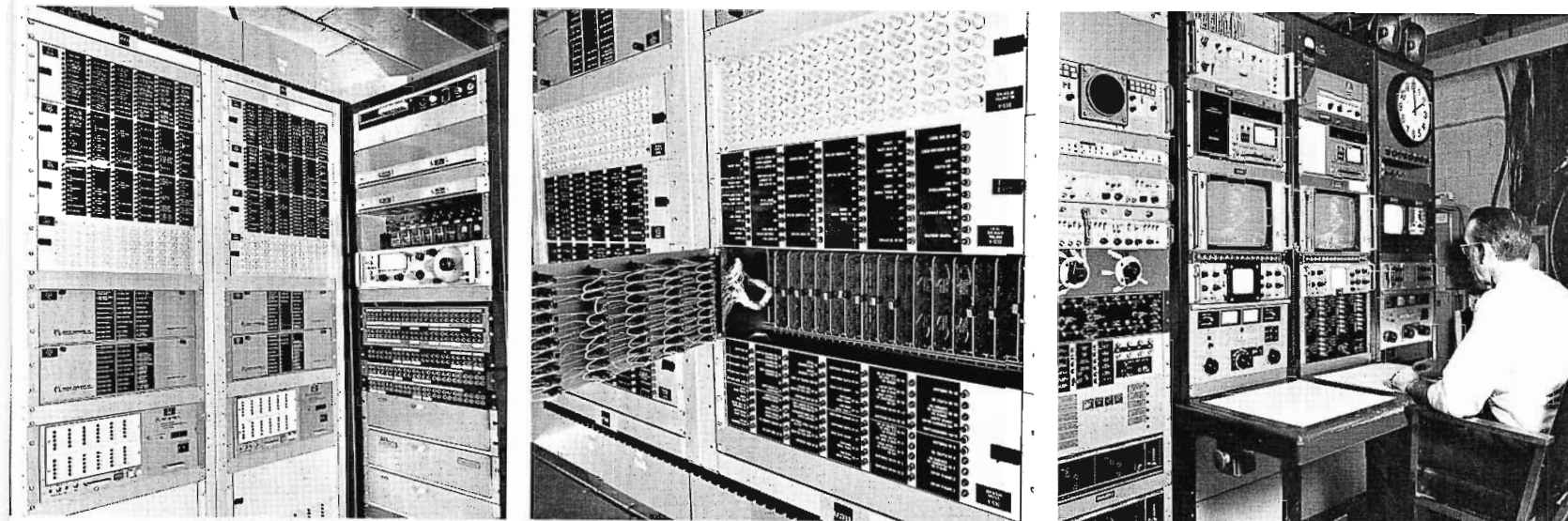

Status interface panel in open position. At bottom is a fuse panel through which all metering inputs are routed before passing into the system.

Redundant remote control system panels at transmitter site. Etched status read-out panels at top identify all control and metering functions of the system.

System monitoring and control position.

KNTV transmitter engineer checks video control flow diagram which provides a visual display of the system elements which are "on-line" at any given time.

- Filterplexer—Air and Reject Load Normal
  - Transmitter "A"—RF Switcher Interlock
  - Transmitter "B"—RF Switcher Interlock
  - Transmitter "A" {
  - Transmitter "B" {
- All External RF Interlocks including the Remote "Fail-Safe" system are functioning

mitters, and their adaptability to the multi-faceted remote operation devised by TV-11.

An 18-ton air conditioning system maintains proper temperature and humidity conditions in the KNTV transmitter building. The transmitters are ducted to a double plenum exhaust system which discharges outside. During cold weather periods, the hot air is re-circulated to heat the inside of the building. There is complete redundancy in the double plenum exhaust system.

is a separate interface designed by KNTV technical personnel. This system uses relay cards and 4-pole relays, with four isolated outputs to provide protection against outages. Because of the isolation and redundancy, an isolated failure could not wipe out the entire system, Mr. Bell notes. Elco plug interconnects are used instead of individual solder connections to the rear of the remote control unit at the transmitter site. This wiring was handled by the TV-11 staff, and makes for easier maintenance, adds Mr. Bell.

The TT-17FH transmitters, Mr. Bell says, operate within  $\frac{1}{2}^\circ$  differential phase and 1% differential gain. He likes the performance of the new trans-

**Interface Systems by KNTV**

Between the remote control interface built into the TT-17FH transmitters and the DCS-2 remote control system

The remote control system is further isolated by another part of the KNTV interface system which routes all sixty metering inputs through a fuse panel before passing into the system.



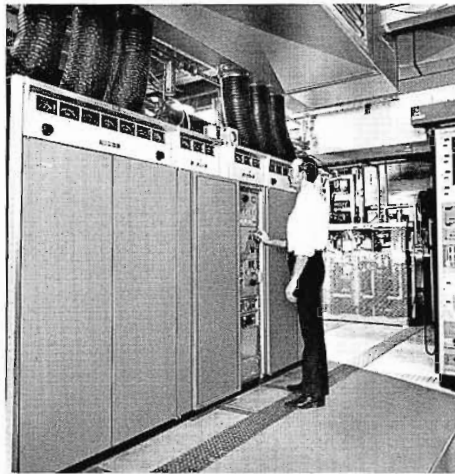

### Status Read-Out Panel

In conjunction with the remote control system, the KNTV staff designed a "Status Read-Out Panel" with etched identification of all control and metering functions. This system is duplicated at the Studio, and uses green lights for "OK" readings, and red LED's (light emitting diodes) for overload or "Not Normal" readings. Four panels comprise this system:

1. Status Interface, Ch. 1-60
2. Control Interface, Ch. 1-30
3. Control Interface, Ch. 31-60
4. Metering (fuse) panel, Ch. 1-60

Through the use of "Raise/Lower" buttons on certain control channels, three functions can be read on the same metering channel, which extends the capability of the system, Mr. Bell notes. On some channels, additional readings are obtained via an 11-step stepper relay. For example, in checking #3 phase voltages, nine voltage samples from various parts of the system can be read by pushing the "Raise" button repetitively. Each depression switches the relay to the next reading position. This is used to check the incoming power from the utility company, and the voltage at various other points in the system. Pressing the "Lower" button returns the relay to Position "1".

The "Status Read-Out Panel" is set for two levels of metering: "ALERT", and "ALARM". If there is a fault in a non-critical metering function, the appropriate status light shows Red. This is the "ALERT" situation. If the problem involves a critical function,

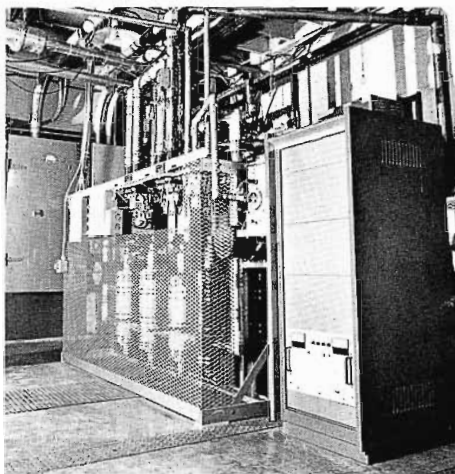

Little floor space is required for the two 17 kW VHF transmitters. The transmitters are ducted to a double plenum exhaust system for outside discharge.

The entire KNTV transmitter RF output system was optimized on site for low VSWR, permitting on-air switching without requiring further adjustment.

the light flashes Red, and an audible alarm sounds. This is the "ALARM" condition.

### Video Control Flow Diagram

In operating a Main-Alternate transmitting system with redundant STL and Remote Control systems, Mr. Bell felt that the transmitter operator must have an exact knowledge at all times of which system elements are on-line. KNTV engineers took care of this requirement with a rack-mounted panel that provides a visual display of the "On-Air" video path. Etched symbols and red tally lights show the circuit crosspoints, giving a positive display of

which system components are active at any particular time. For example:

- Microwave System #1 or #2
- TA-19 Proc Amp "A", "B", or "C"
- Video Delay Equalizer #1 or #2
- Transmitter "A" or "B"

The result is a single line flow diagram of video control. The system operates from 4 x 1 reed switchers, with battery-operated IC logic. The 24V logic system has built-in batteries, should power fail. These are good for 10 hours of operation, then battery power would be obtained from the emergency generator batteries.

This "On-Air" flow diagram will be duplicated at the Studio so personnel there will have a positive indication that commands from the Studio via the remote control system have been acted on.

### "Inhibit/Enable" Switches

Since the transmitters are remote operated from the studio, Lou Bell decided that extra protection had to be provided at the transmitters to inhibit the remote control functions while testing or maintenance work was being performed. Each of the TV-11 transmitters has been equipped with "Enable/Inhibit" switches. When these heavy duty, 4-pole toggle switches are placed in the "Inhibit" position, commands from the studio via the Remote Control system will be inhibited. No functions can be turned on or operated remotely while the switch is in this position. This arrangement permits working on the transmitter with positive knowledge that none of the functions can be activated from the studio.

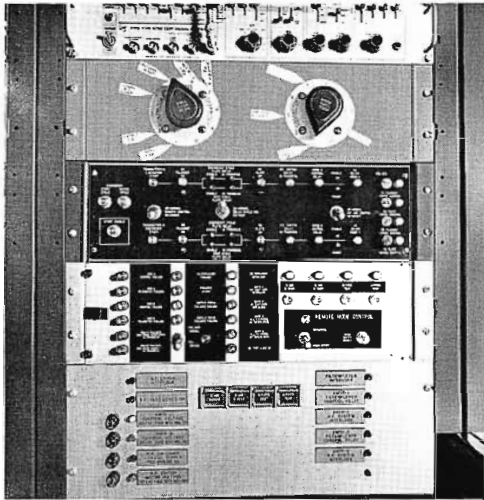

Monitoring and status displays for KNTV transmitter operation. Lower panel is logic system for RF switching sequences. The panel above this displays the "Summation of Control Data" referred to in text.

Inhibit/Enable switches are installed in each TT-17FH Transmitter to inhibit remote control functions during test or maintenance operations.

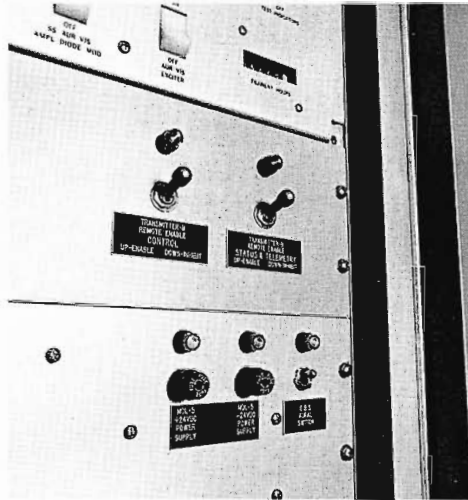

"Enable/Inhibit" switches are also installed in three other transmitter room locations: Video Switching; Audio Control; Emergency Generator. The positions of these switches also show as lights on the central control panel in the transmitter room. Mr. Bell refers to this as the "Go Home" panel. Before leaving the building to go home, the transmitter maintenance personnel must check to be sure that none of these system "Inhibit" lights are on.

#### Two More Test and Display Panels

Two other panels in the control racks provide additional system checks at the transmitter site. One panel is a 16-position test switcher with outputs to a video waveform monitor, and is used for quick readings and fast checks of transmitter performance parameters.

The second panel shows a "Summation of Control Data". This lighted display indicates: RF Switcher Control; RF Switcher Auxiliary Frame; and Control or Telemetry Failures. This last light would indicate that the "Fail-Safe" system one-hour countdown is in process, and identifies whether it is the "A" or "B" transmitter.

#### The System Delivers

As expected, KNTV's Main-Alternate transmitting system is delivering a powerful color picture throughout the coverage area. The digital remote control system provides complete metering and control capability, with virtually unlimited flexibility for future needs. Moreover, the innovative custom designs added to the system by the talented TV-11 technical staff extend a new degree of security to equipment and personnel. □

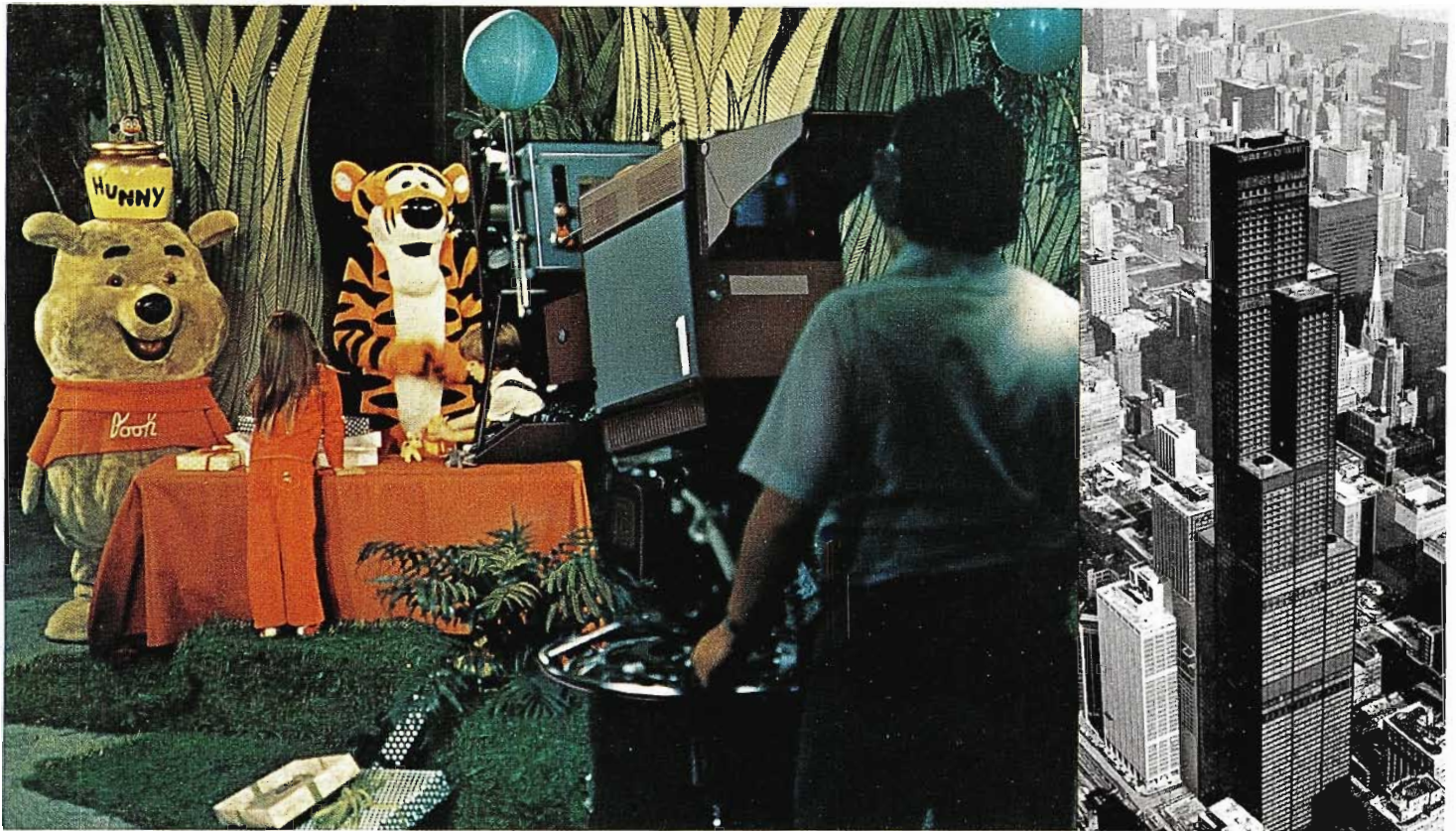

"Winnie the Pooh" and "Tig" face the cameras during a production session in the Sears Television Center on the 27th floor of Sears Tower.

## BUSTLING SEARS TOWER TELEVISION CENTER SERVES OVER 100 "CLIENTS"

**W**hat's your problem?

Is it communication . . . motivation . . . identity . . . information . . . training?

This message opens a video tape directed to management and more than 100 "client" operations in the mammoth Sears Tower headquarters in Chicago. The tape, produced under the direction of John Connelly, Manager, Sears Conference Center and Audio-Visual Facilities, presents an overview of the facilities he manages.

Impressive is an accurate descriptive word for this operation, since all electronic audio visual facilities for the Tower are consolidated in one department, which operates the 27th floor.

Located on this floor are five separate, professionally equipped Audio-Visual/Conference Rooms; three different television systems; a building-wide distribution center; two sound studios; administrative offices, and a "loaner pool" of more than 1,000 pieces of audio-visual equipment.

### TV Production Center

The television production center is a carefully planned, well-equipped facility that more than matches many broadcast studios. It includes three TK-45 color cameras with "prompter" attachments and shot boxes; video and audio switchers; a TK-28 film system with 16mm and Super 8 film projectors; graphics camera; two TR-70 quadruplex tape

recorders with separate editing console; 1-inch helical scan and videocassette record and playback units.

The layout of the TV facility is compact and functional. There is a main studio and adjoining control room; a separate distribution (Master Control) area with video and audio monitoring and controls; film island and a battery of helical scan and videocassette tape machines. An adjoining humidity-controlled area houses the quad TR-70's and editing console. Additional facilities include two preview/screening rooms; dressing rooms; prop and tape storage areas.

### Heavy Production Schedule

The Sears television center has demon-

strated its competence, and is booked solidly for months in advance. The range of assignments is diversified, but all are directed toward the objective of solving a communications problem. One day the Chairman of the Board may come to the studio to tape a community service message. This may be followed by an elaborate set and production to introduce a new merchandise line.

With some 100 different departments as "clients", little wonder that the TV center operates a heavy production schedule, sometimes having three separate productions going on simultaneously.

Major users of the system are:

- Merchandising and Marketing  
(largest using group)
- Catalog
- Personnel
- Training
- Management Information
- Public Relations

Mike Bozidarevic, Manager of the Television Studio, has watched the Sears television capability grow from a small monochrome camera set-up to the present full color, broadcast quality installation. In discussing the TV operation which he manages, Mr. Bozidarevic is most enthusiastic about working in an environment where there is an infinite variety of assignments to challenge and satisfy creative needs—and which also affords the opportunity for active involvement in all phases of television.

#### **TV A Tool, Not A Panacea**

Television at Sears, John Connelly notes, is used to augment other communication systems. TV is particularly effective for special events, new marketing concepts, introducing new merchandise and highlighting special in-store displays. It is fast and easy to duplicate and distribute material via television. However, Mr. Connelly considers television as a communications tool, not a panacea. For example, he says, a line review of major appliances lends itself beautifully to a television presentation. The entire line can be covered in a studio TV production, with colorful, dramatic staging and effects. The result-

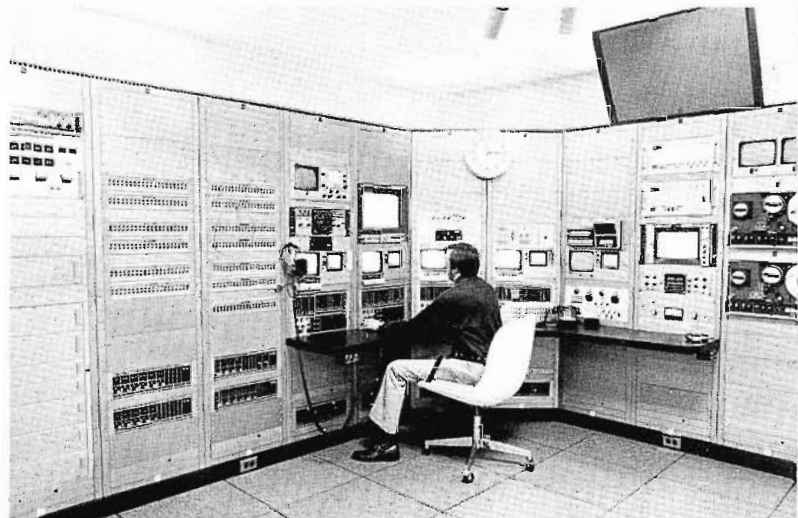

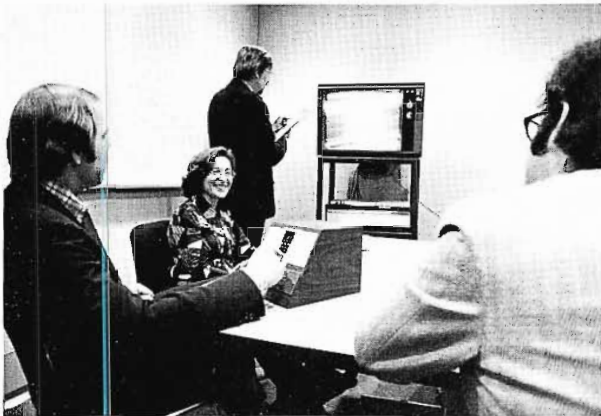

(Top left)

The TV Distribution Center is the major equipment room, including video control; master program distribution; film island; video tape facilities. Standing by film system is Mike Bozidarevic, Manager of Television Studio.

Video control position includes complete monitoring facilities and camera controls for TK-45 and TK-28 cameras in a convenient corner arrangement. Ample space is provided behind racks for service accessibility. Operating the camera controls is Bruce Wallace.

Two TR-70 Tape Recorders with editing console are located in a separate, humidity-controlled room adjoining the TV Distribution Area. The Video Tape Operator is Richard Coxworth.

(Top right)

Production control positions are on a raised platform looking into the studio. Monitors are recessed above the window. A separate client viewing space is located next to the control room.

Preview/Editing room is equipped with a television receiver and a videocassette recorder, and is frequently used by writers, directors and producers for client conferences.

ing video tape can be duplicated and sent to regional offices, saving considerable time, effort and travel expenses—and getting the message through faster to a broader audience and with more impact.

A major function of the Television Center is communication with the Sears retail and catalog units in the field. Every territorial office, each catalog distribution center, and most of the retail Group and Zone offices around the country are equipped with TV playback equipment. In large part, the tapes going to these offices are related to merchandise. This is understandable, considering that Sears sells more than 100,000 items which are constantly changing to reflect market conditions and tastes. Television is an effective vehicle for highlighting merchandising messages to key field locations.

#### “Show Biz” Productions

The TV Center has demonstrated its creative capability in producing colorful, dramatic video tapes to serve as motivational “openers” for meetings.

One memorable example:

A paint merchandising program was prefaced by a video tape adaptation of the opening scene for “Patton”—complete with a full screen American Flag and a gravel-voiced, profusely decorated “general” exhorting his troops to charge out and be “Number One”.

The “Toy Show” is another annual television production which has been extremely successful in introducing the year’s new line of toys. This production, usually tied to a seasonal merchandising theme, replaces a traveling road show caravan which visited major offices to show the new toy lines and programs. Putting the toy show on tape saved time, money and manpower. Instead of the toy caravan, videocassette tapes were sent to meetings around the country. More people saw the toys, heard the words and understood the message than ever before, Mr. Connelly reports.

Some Merchandising Departments are located in New York, but come to the Tower and use the studio for presenting their lines on television. These lines—

#### Evolution of TV at Sears

Problem-solving was the basis for Sears utilizing television, beginning in 1965, when a “live” meeting was televised and taped, using rented equipment. In 1968, the Advertising Department moved to Skokie, Ill., some 20 miles from the West Side (Chicago) headquarters of Sears. With this physical separation, communications became a more critical problem. Checking advertising layouts with the Merchandising staff at the West Side was time-consuming and entailed extensive travel between the two locations. A basic monochrome TV system at each site, with two-way voice communication alleviated the problem. The cameras were equipped with zoom lenses for transmitting closeups of layouts so corrections and changes could be discussed and made in full view of all involved in the decisions. Television solved the communications problem and eliminated much unproductive transit time between the locations.

With this effective beginning, other possibilities for television were considered. In 1969, outside studio facilities were used for a TV production, in color, of a special meeting. The quad tapes produced were dubbed to 1-inch helical scan format, and these tapes were sent to seven locations throughout the country where simultaneous (concurrent) management meetings were scheduled. Two-way telephone hook-ups connected all locations. The tapes were played back at each meeting site simultaneously at pre-designated times, following which the phone “intercom” was used for questions and elaborating detail.

Again, the success of this use of television for widespread communication led to further application. Television services from outside resources were being sufficiently utilized to warrant a comparison of the outside versus internal costs for anticipated production requirements.

A new one-camera color system stemmed from this 1969 study. In 1971, a second camera, film chain, and production switching system were added. Subsequently, some 300 television productions were handled by this system.

John Connelly, Manager, Conference Center and Audio-Visual Facilities, confers with John Cunningham, Assistant Manager, at the main elevator entrance to the 27th Floor. Color spectrum in background is also functional, identifying major floor locations by name and color code.

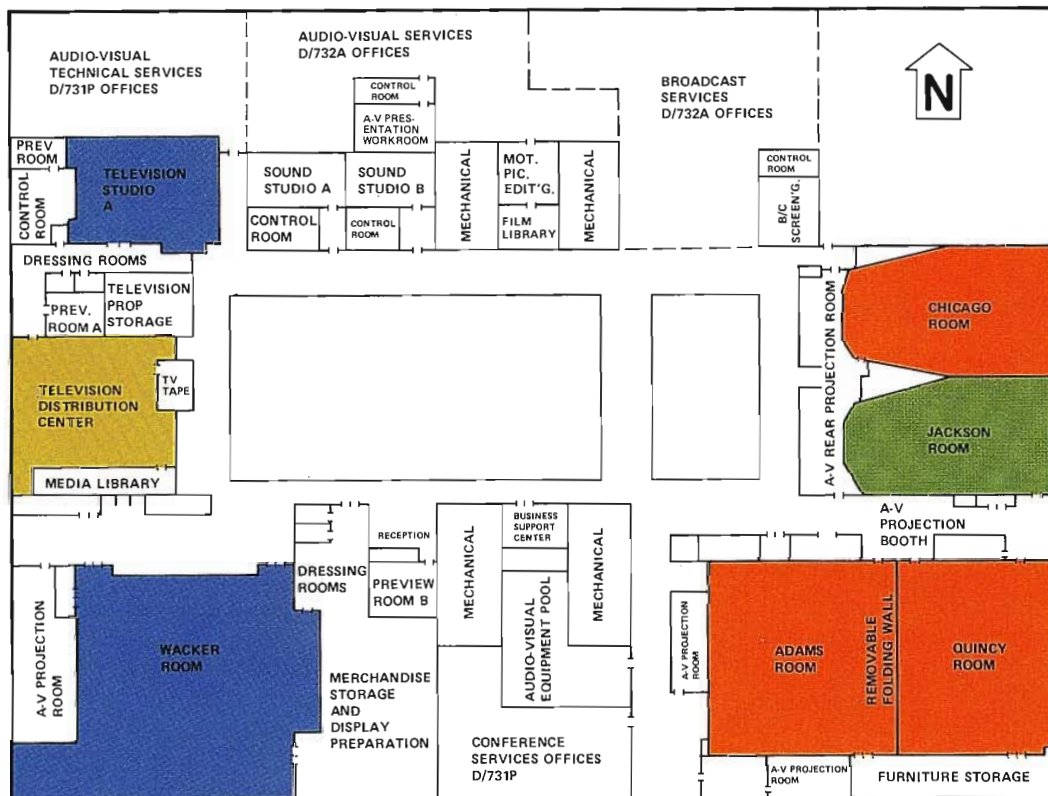
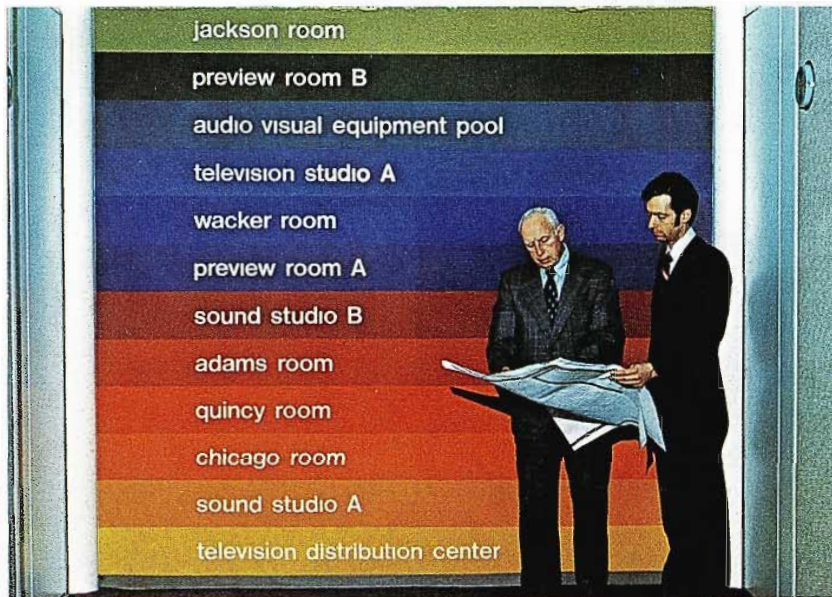

Layout of the 27th floor reflects careful planning for the Conference Center and Audio-Visual Facilities. Five Conference Rooms are fully equipped with A/V and television facilities.

cosmetics, fashions and luggage—are among those where color is essential for an accurate visual presentation of the product as well as for audience impact.

### Centralized A/V Facilities

With the building of the Tower, careful consideration was given to planning the overall communications facility. John Cunningham, Assistant Manager of the complex, who was intimately involved in the technical design and planning pointed out that this effort involved a thorough analysis of needs by outside consultants as well as by internal personnel. The resulting recommendation centralized most audio-visual facilities and services in one department. Included in this plan was the expanded broadcast quality color television system now installed, as well as the building-wide TV distribution system and sound recording studios.

However, Mr. Connelly is quick to point out that many people in Sears pioneered in the use of audio-visual systems, thus getting the company to the point where it could take advantage of the rapid advances of today's sophisticated A/V systems and use the system that it now has. Without the work and vision of many Sears executives in the merchandising, advertising, training, public relations and other areas of the company, the television and sound recording systems Sears now has just wouldn't exist.

### A/V Conference Facilities

While television is perhaps the "glamour" operation of the 27th floor, it is only one of many Audio-Visual resources in the center. For example, there are complete A/V facilities for handling up to 600 people simultaneously in five meeting rooms. These meeting areas are:

*Quincy Room and Adams Room*—adjoining spaces with a movable sound-proof wall. The rooms can be combined to handle over 400 people. All rooms have fully equipped projection booths and lighting controls.

*Chicago Room* has tiered seating for 54 people and is equipped for rear screen projection.

*Jackson Room* is equipped for quad image rear screen projection and is used mostly for training.

*Wacker Room* is the largest and most sophisticated of the meeting rooms and

was especially designed for multi-media presentations.

The Audio-Visual/Conference Services activity is also responsible for servicing a variety of conference rooms throughout the Tower. There are more than 200 such rooms, set up to handle meetings of 8 to 50 people. All of the 45 large conference areas are wired for television reception as, of course, are the five large meeting rooms on the 27th floor. The main meeting rooms are also equipped with camera cable connections, permitting the color cameras to be moved from the main studio and used in any meeting room. The TK-45 camera's ability to perform at low light levels is a useful feature in utilizing the conference areas as additional studio facilities. This capability, Mike Bozidarevic notes, adds much flexibility to the TV operation—flexibility that is needed to accommodate growing production demands.

In addition to the major studio TV system, there is another color TV system—1-inch—set up in the projection booth area behind the Jackson Room and is used mostly for simpler productions and for training and seminars such as effective communications, interview techniques and role-playing. A third system with monochrome camera and videocassette recorder is set up in one of the preview/editing rooms for those who wish to get the "feel" of television before going on camera in the main studio, as well as for training purposes.

#### A/V "Loaner" Pool

The Audio-Visual Conference Center services over 200 conference rooms throughout the Tower, and is the resource center for more than 1,000 pieces of audio-visual equipment—television monitors; videocassette players; tape recorders; 16mm, slide, filmstrip and overhead projectors. The department fields more than 200 requests for "loaners" each week; operates a maintenance and repair shop, and is capable of meeting just about any requirement—even complex multi-screen productions.

#### TV Distribution System

A communications shaft—1' x 6'—built into the Tower covers the entire building. The master TV distribution system is controlled from the 27th floor and is connected to about 90 locations throughout the Tower. With this internal network, video messages can



For added versatility, conference rooms are equipped with camera cable connections, and can be used as additional studio sets for TV productions. Photo above shows Wacker Room as a schoolhouse set.

Two professional sound recording studios are a part of the resources available through Audio-Visual Facilities. Manning the audio mixing console is Jerry Bush.



The AV "Loaner" pool involves more than 1,000 pieces of equipment including TV monitors and videocassette players as well as the conventional projectors and meeting accessories.

TV staff members have an opportunity to develop skills in various television production areas—camera, lighting, audio, switching, directing, editing.

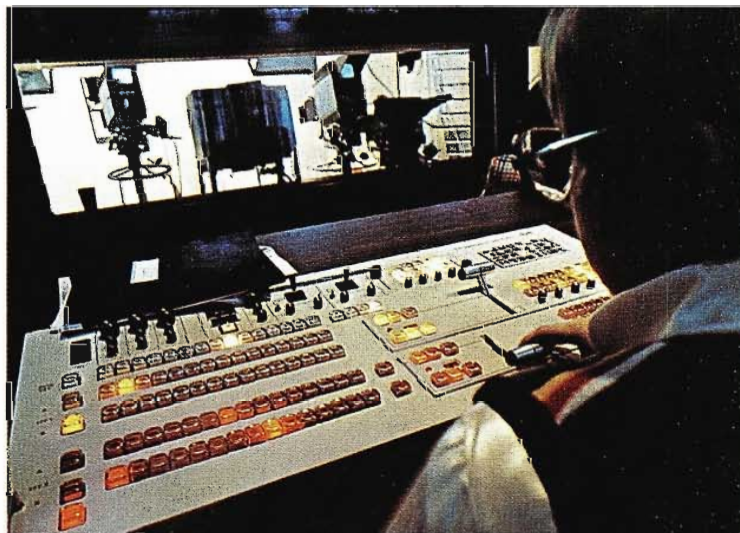

cover all Tower employees (more than 7,000) in less than three days. Obviously television is not used for routine communications, but has been used for covering such topics as: new employee benefits; annual profit-sharing report; Community Fund drives; updates on major merchandising programs, and other corporate communications of interest to Sears employees.

This system is expandable to cover the entire building as needed.

The distribution system has 20 inputs and can distribute programs from all local VHF and UHF stations (down-converted) plus four separate Sears channels.

#### **Sound Studios**

Sound recording is another A/V service which is much in demand. Two fully-equipped sound studios on the 27th floor are kept busy handling original recording for audio, slide and filmstrip presentations. These studios also supply background sound and special audio effects for television productions.

#### **Versatile Staff**

The Sears television operation, Mike

Bozidarevic notes, differs from broadcast program production where the performers are professionals. And it is unlike teleproduction centers where outside producers, directors and talent are largely utilized. At Sears, with few exceptions, the on-camera talent as well as the technical and complete production crew are employees.

The TV studio directors work daily with writers, producers and communicators from other departments to get the job done. The team concept is vital both within the studio and with client departments. Versatility is encouraged . . . and required.

The Television Studio staff, Mr. Bozidarevic adds, is expected to produce shows that measure up to commercial standards. "Color is only a part of it," he says. "The overall production must reflect professionalism. Clients are more sophisticated and insist on creative effects, lighting, color and edits that will impact on the audience."

The ability to participate in both creative and technical areas is particularly important to Mr. Bozidarevic. Intense and involved, he views his position

more as a lifestyle than as an occupation. "Television is a fast-moving, constantly evolving field," he says. "You must plan 5 to 10 years ahead, allowing for expansion and providing as much flexibility as possible. Satisfaction with the status quo is dangerous," he adds.

One of the trends Mr. Bozidarevic sees developing rapidly in the corporate television field as well as in broadcasting is for more "on-location" production. The new equipment now becoming available makes this method of operation feasible and affordable. The Sears TV staff has already done some remotes using rented equipment, he says.

#### **Utilization—Key to Success**

Utilization, a result of top management involvement and support, has been the key to Sears success in operating its television center. The equipment is capable of top quality performance. Equally important, the versatile television studio staff has the technical and creative competence needed to sustain a solid schedule of production assignments—ordinary and extraordinary. □



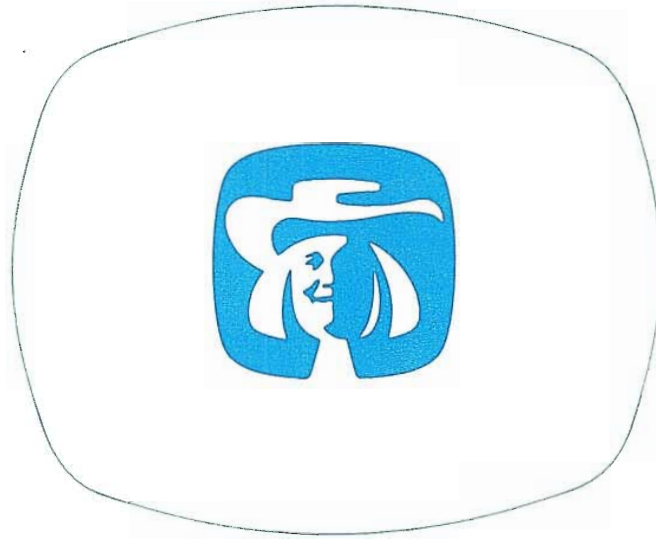

## Quaker Builds Corporate TV Capability On **COST EFFECTIVENESS**

**T**HE FAMILIAR, old Quaker Man in the wide-brimmed hat is alive and well, identifying a whole lot more than oatmeal or cereals "shot from guns." Today, almost 100 years since the Quaker Oats trademark was registered, the Quaker Man represents everything from Quaker cereals, Aunt Jemima and Celeste brand foods, Burry cookies and crackers, and Puss 'n Boots and Ken-L Ration pet foods to Fisher-Price toys, yarns and art needlecraft supplies, Quaker Chemicals and Magic Pan Restaurants. The Quaker Oats Company today is a highly diversified, worldwide business with annual sales of more than \$1.5 billion.

### **Active Corporate Communications Effort**

The very diversity of the organization, plus its highly competitive consumer market orientation mandates a significant role for the internal corporate communications function. Quaker's Visual Communication Staff, under the direction of Tom Krasin, is part of the company's total internal communications group, encompassing all tradition-

al employee communications activities, as well as audio-visual services.

The group is headed by Dick Kozitka, Director-Employee and Audio-Visual Communications, who reports to the Senior Vice President—Corporate Affairs.

The Visual Communications staff under Tom Krasin is responsible for all corporate television and audio-visual needs. With a staff of nine, Tom's group provides complete in-house capability, functioning like an agency with a "client" roster of some 30 Quaker departments and divisions. The staff is located at Quaker's corporate headquarters in Chicago's Merchandise Mart.

Quaker's involvement in closed circuit television began in 1969. Since then, there has been a continuing upgrading of equipment and facilities.

### **TK-630 Color Cameras**

Two TK-630 color cameras divide their time between studio assignments and location shooting. The cameras are

hailed or air-shipped wherever needed. They have been operated in extreme heat, cold and high humidity conditions. One thing they have *not* been, according to Tom Krasin, is pampered. He is pleased with the performance, the dependability and particularly the excellent color his TK-630's deliver.

The two TK-630 cameras, with lenses, tripods and control units travel in four custom-built foam-lined aluminum cases. For distant locations they are usually air-freighted, and have been able to survive the potential hazards of less-than-gentle handling.

On one road swing to produce a video tape showing the sales organization a range of different store operations, the cameras were loaded aboard a Sightseer II recreation vehicle for a 6,500-mile, four-city jaunt. The cameras performed on location at preselected retail stores at Denver, Rye, N. Y., and Tampa. Seven hours of tape were edited into three 15-minute segments depicting different types of retailing operations. The fourth stop, while enroute to a national sales meeting in Florida, was

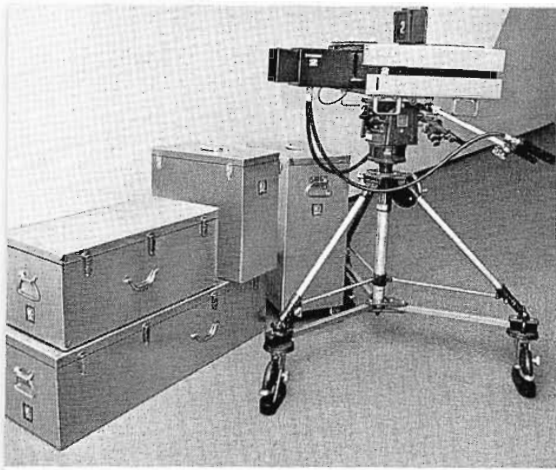

Staff member Linda Colberg handles TK-630 camera on set, while Producer/Writer Kathie Farnum views the action.

Dave Shoch makes an adjustment on TK-610 Film Camera.

Studio production set-up, with video operator on left; switching and audio console at right. Functioning as the TD is Tom Krasin, Manager, Visual Communications.

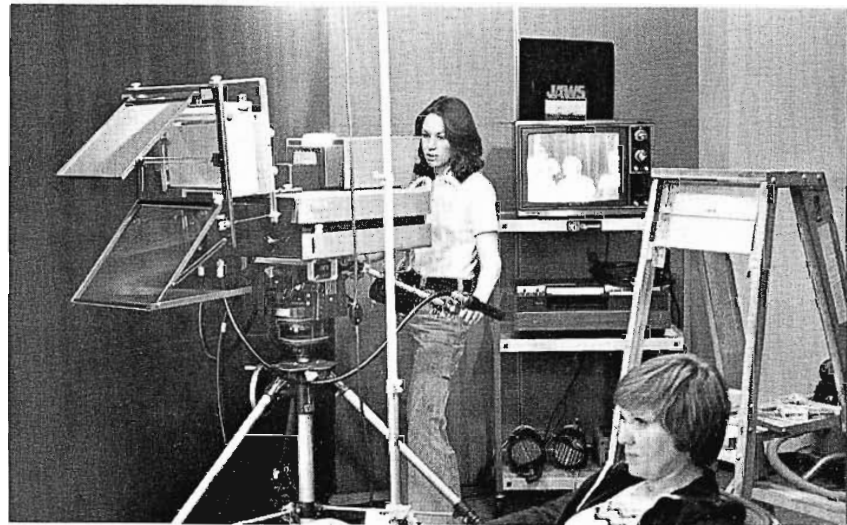

made in Jackson, Tennessee to televise a new frozen food plant opened by Quaker. The resulting video tape served as an effective orientation and information aid for corporate management personnel.

**Hectic Sales Meeting Schedule**

While in Florida, the cameras handled a variety of assignments. For one of these, the TK-630's were mounted atop a Sightseer II motorhome under a broiling 95-degree sun, and suffered no ill effects, while making beautiful pictures.

A national sales meeting involving more than 600 people from Quaker's Grocery Products Group was held in a spacious condominium/resort/convention facility near Tampa. At this meeting, television was the medium most frequently used, placing the major responsibility for program support on Tom Krasin's Visual Communications staff.

Setting up the production and program-

ming facility on a tight schedule was hardly a picnic. The complement of television and audio visual equipment owned by the Visual Communications group, supplemented by an array of rented equipment, (over 3 tons of gear) was shipped from Chicago to Florida and installed by Mr. Krasin and his staff. Only three days were allotted for the set-up, and the system was in operation for all four days of the meeting.

A variety of television formats were employed, and the entire staff worked night and day developing and programming the TV productions. Some video and audio tapes were made on site, and integrated with slides and inserts.

**Bedroom/Living Room for Studio-Master Control**

Scheduled broadcasts throughout the meeting were carried over an assigned channel on the resort's master antenna system, and included news, sports and informational presentations. Three times

each day, the Visual Communications staff conducted TV interviews in the "studio"—which was a part of a bedroom-living room combination that served as studio and master control. Down the hall, another suite served as an editing facility.

The studio included a video switcher with Chroma Key; camera controls; Time Base Corrector, and an extensive assortment of audio gear. In fact, the audio portion of the system alone included more than a mile of microphone cable strung around the meeting facilities.

Three live cameras, including the two TK-630's were in almost continuous operation at the meetings. Positioned on scaffolds, in the Conference Center, two cameras focused on live speakers and fed the image to a 9' x 12' screen via rear screen video projection. The other camera fed the video screen from a live studio set up behind the stage in the Conference Center. Eighteen

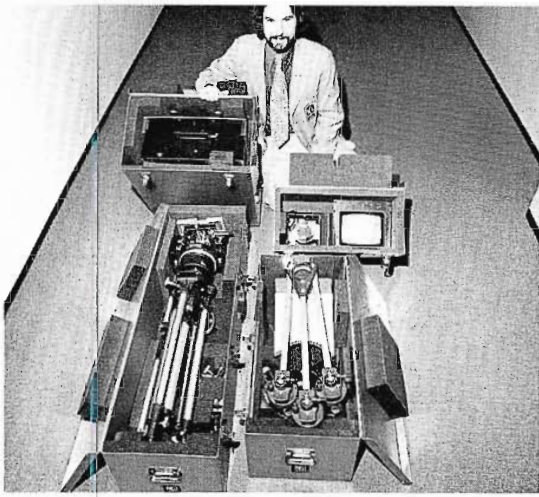

For location work, Quaker ships their TK-630 cameras in special foam-padded aluminum cases. Picture sequence (left) shows one of the cameras being packed for shipment.



television sets, located throughout the main meeting area, gave everyone an unobstructed view of the "video impact" feeling. (The environment in the Conference Center was designed to resemble Mission Control to tie-in with a space-age theme for the overall meeting.)

#### On-Site Sports Coverage

The cameras were used for early morning telecasts to advise participants of the events of the day. Then the cameras and VTR's were transferred to the Conference Center for live video projection. Five recorders were used for taping and playback.

During "free" times when no sessions were scheduled, the crew toured the golf course, tennis courts and fishing boat with portable TV cameras, taping sports activities and matches. These tapes were edited and integrated into the evening newscast.

Yet another function of the TV system during the meeting was to serve as a message center. A character generator handled this task, and was also used in the post-production editing sessions.

With all of the real and potential problems involved in using television as the prime medium for the Quaker sales meeting, the results turned out quite well, Tom Krasin proudly notes.

#### Accelerating Video Activity

In addition to handling sales meetings and frequent road assignments, the Quaker television system is also "at home" in the headquarters studio which is also a well-utilized facility.

Areas of accelerating video activity include employee communications (orientation, benefits, news, etc.); management training and development; sales training; commercial testing and other work for AdCom, Quaker's in-house advertising agency; safety and other awareness programs; and the develop-

mental programs such as role playing and public speaking.

One of the reasons for the heavy accent on TV is Tom Krasin's unabashed enthusiasm for television as a communications tool. He sees video as the medium of today and the future because it offers immediacy; lends itself to fast editing; is flexible, and saves time.

The Visual Communications group functions on the basis of cost-effectiveness. Internal operations are monitored and costs are regularly checked against outside sources to verify efficiency.

As Tom Krasin notes, his is not a "show business" group, but is a business organization and should be held accountable on the same basis as other business operations.

At Quaker, through the efforts of a talented, innovative staff, television is meeting this performance requirement. □

# GIANT FILM AND TV PRODUCTION COMPLEX ADDS A NEW RECORDING STAGE

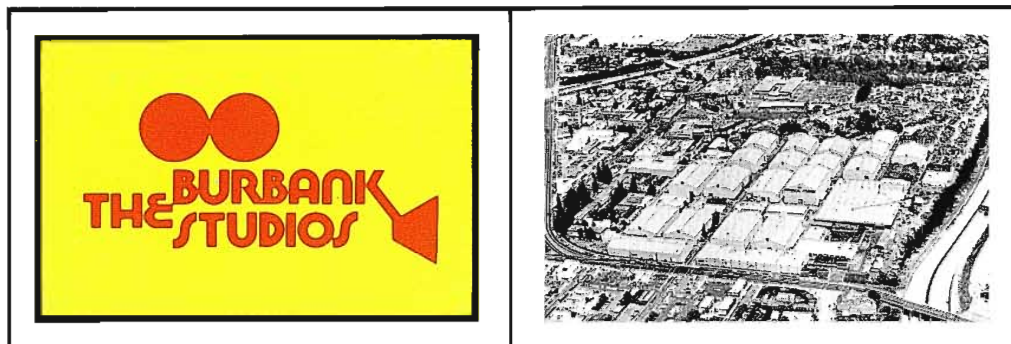

**T**HE Burbank Studios—or “TBS” as it is more commonly referred to locally and in the industry—offers a combination of facilities, equipment and talent for production and post-production of film and video that is colossal in magnitude.

The sprawling complex covers 130 acres, encompassing a host of specialized facilities for motion picture and television production.

TBS is a joint venture of Columbia Pictures and Warner Bros. Pictures. Robert K. Hagel, President of TBS, calls it a “total concept” production center—an environment which places no restrictions on creativity. It is structured as a complete resource center for production and post-production.

At TBS, sound and picture get equal attention. In fact, some of the most sophisticated electronic systems in the studios are devoted to achieving the finest in audio. No audio requirement seemingly could be beyond the scope of the comprehensive Groves-Rice sound complex which, fittingly, is named for two pioneer film industry sound engineers. Sound facilities there include:

- Recording Stages
- Scoring Stages

- Mix-down Stages
- Looping (dialog replacement) Stages
- Re-recording (dubbing) Stages

Among the newest sound facilities at TBS is a re-recording stage which the studio has designated as “Dubbing Five”. RCA Photophone, now a part of RCA Broadcast Systems, worked closely with The Burbank Studios’ engineering staff and supplied a major portion of the recording equipment for this complex.

Included in the system are: the new FR-35, 35mm Servo-Controlled Projector; PM-85HS, Hi-Speed Dual Dubbers; FR-10 Master Recorders, and a PX-31 Hi-Speed Interlock System.

According to Al Green, Sound Director, Post-Production Facilities, this use-oriented system is designed for quick and easy manipulation, yet has ample versatility for adapting to future needs. The built-in capabilities look toward automated mixing possibilities, he further notes.

“Dubbing Five” is where all of the previously recorded sound elements—dialog, music and effects—are assembled for dubbing or re-recording. Responsible for this critical post pro-

duction operation at TBS is the Chief Re-recording Mixer, Arthur Piantadosi, who also serves as the Assistant Sound Director.

As many as 30 to 40 separate audio elements may be used for finalizing the recording of a single reel (approximately 1,000 feet of 35mm film).

At “Dubbing Five”, final mixing is done on an elaborate, highly sophisticated audio console with three positions—for music, effects and dialog. Usually one sound mixer is responsible for each of these elements, under the direction of the chief re-recording mixer.

The mixing console also has remote operating controls for the RCA FR-35 servo-controlled projector which is located in a projection booth at the rear of the room. Film footages to be mixed are pre-selected, and the projector can be programmed to shuttle between these footages at normal cine speed (24 fps) or six times speed.

Audio program material to be mixed is threaded on a battery of dubbers which are located in a separate machine room. A total of fifteen RCA PM-85HS Dual Dubbers frame two walls of this room. Three of these dubbers are capable of playing back three tracks on each side (18 tracks).

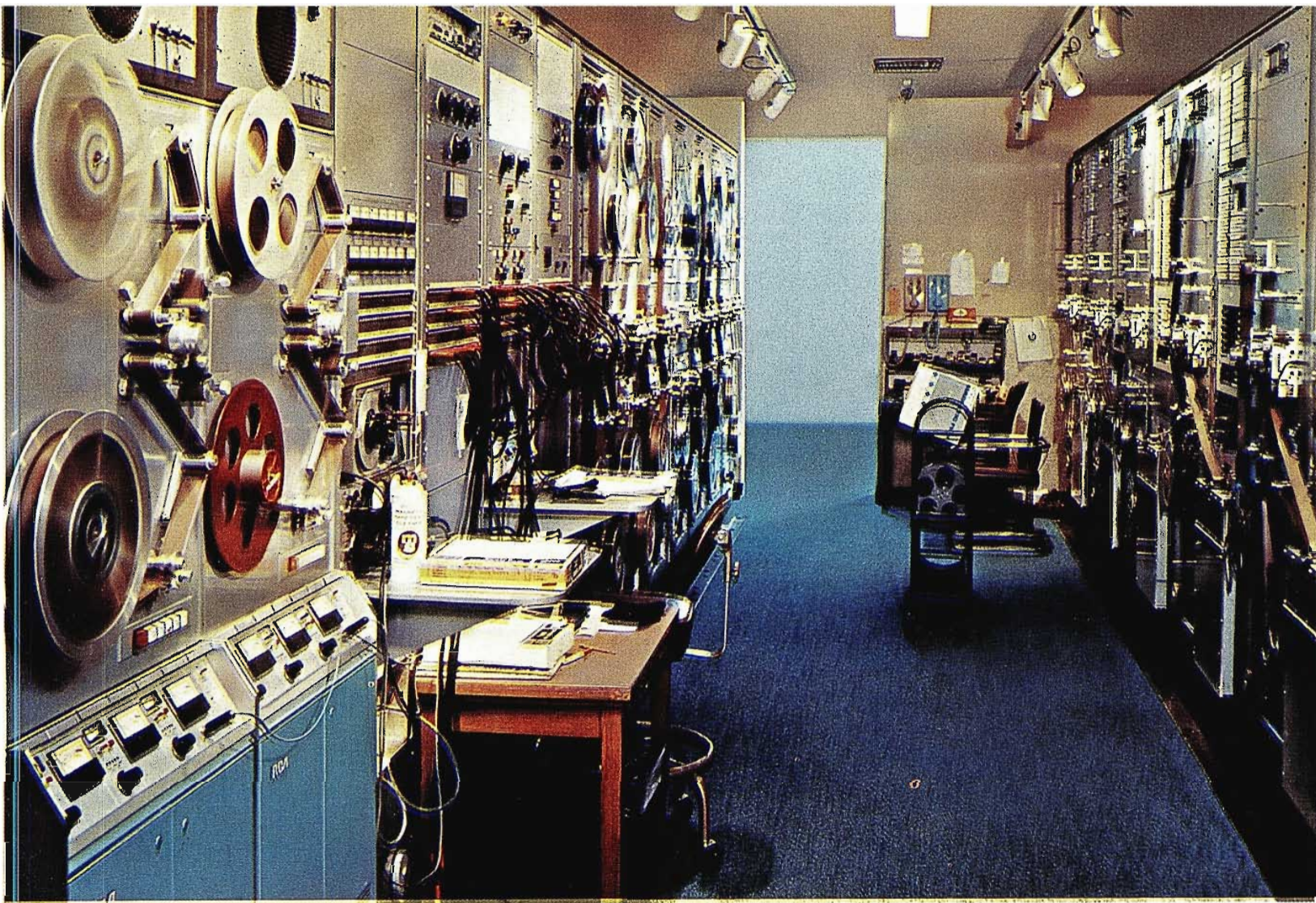

Machine room of the new "Dubbing Five" re-recording stage at The Burbank Studios is lined with RCA reproducers and master recorders, all interlocked for synchronous operation.

Sophisticated three-position TBS motion picture re-recording console handles up to 42 inputs, with as many as 8 mixed outputs. Shown (right) are Arthur Plantadosi, Chief Rerecording Mixer (foreground); Les Fresholtz and Dick Alexander.

The "Dubbing Five" system is controlled from the re-recording console. Pushbutton panel at the left of the operator's hand is the Master Interlock for controlling machine operation. The "Counter Data Entry" pushbuttons at upper left are used for entering start and stop footages into the system.



The other twelve dubbers are single track systems, making a total of forty-two sources available for mixing at any one time. The entire system is interlocked by a logic-controlled Master Distributor system for synchronous operation in forward and reverse at normal or six times the cine speed of 24 fps. In addition, external to the interlocked system, a total of eighteen more audio tape loops on 1/4-inch cartridges are available for inserting special sound effects.

Rounding out the system are two RCA FR-10 Master Magnetic Recorders. These are equipped with interlock motors compatible with the high speed interlock system.

The end result of the re-recording operation is a composite soundtrack which meshes precisely with the picture action. It is properly equalized for smooth or desired volume level variations from scene-to-scene.

The philosophy of The Burbank Studios is sometimes expressed as "The name of the game is keeping ahead of it". In "keeping ahead", TBS is continuously upgrading and adding to their already vast film and television production facilities. The new "Dubbing Five" re-recording stage typifies this on-going effort.

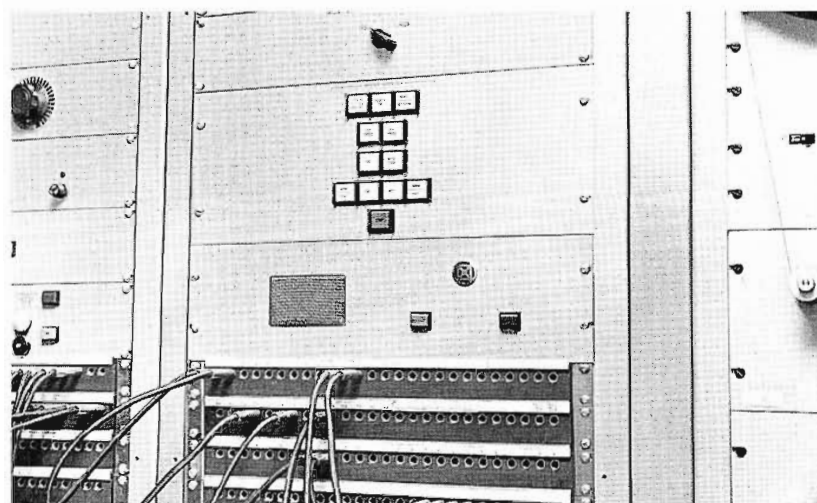
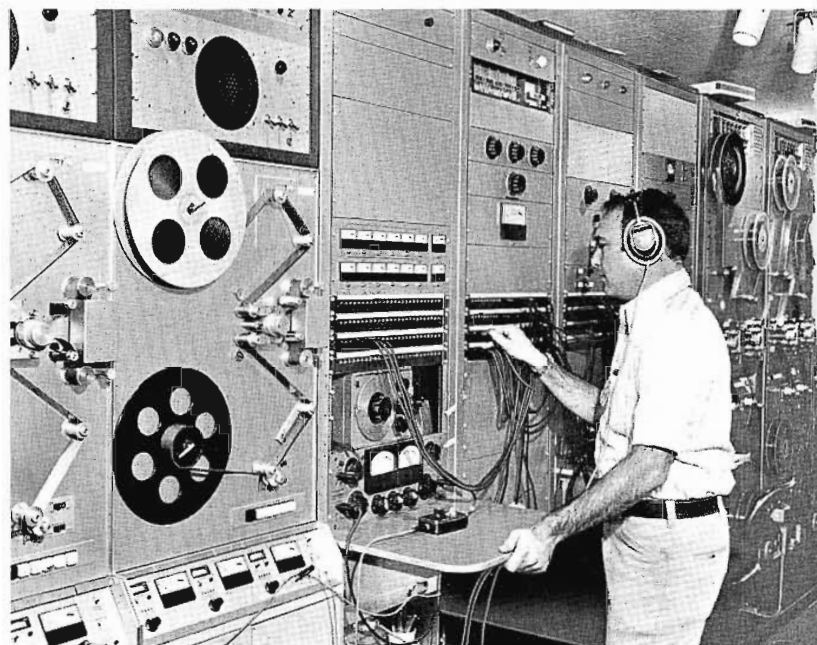
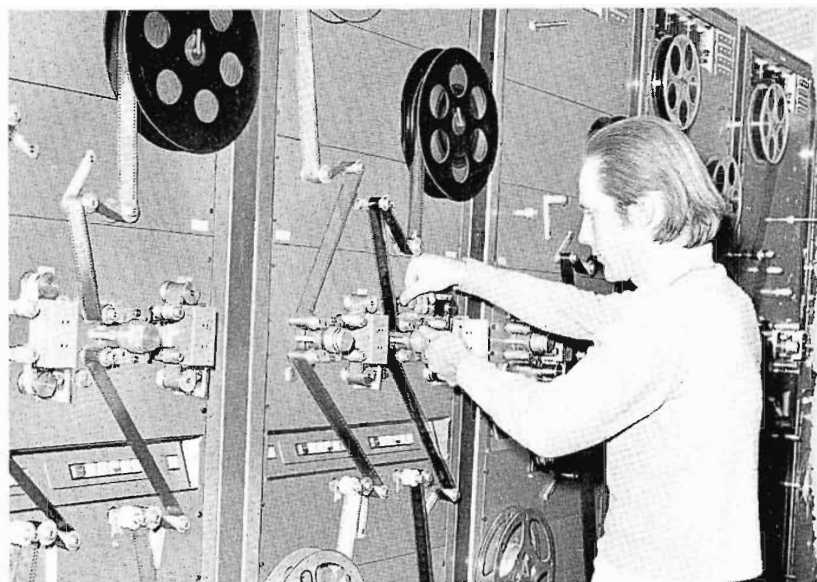

Operator Timothy Green loads one of the 15 RCA PM-85 Dual Dubbers in the machine room.

With 42 audio sources available, extensive monitoring and metering facilities are needed. Machine in foreground is FR-10 Master Recorder.

Pushbutton Distributor Control Panel (Master Interlock). Normally control of the system is delegated to the mixing console in the theatre, where a duplicate panel is installed.

A minimum of rack space is needed for the solid state AL-70 logic and electronics which control the entire distribution system.

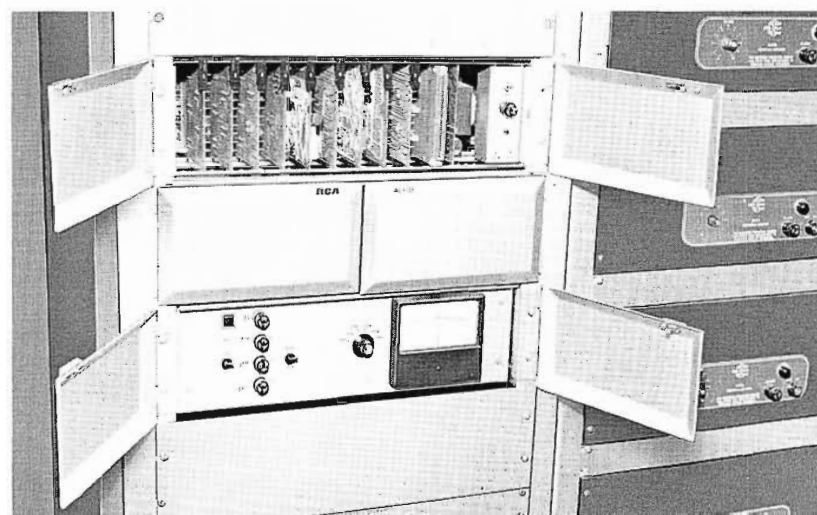

# About Sound-On-Film Recording . . .

Equipment involved in the film recording operation includes:

- Microphones
- 1/4" Portable Production Recorders
- Sprocketed Magnetic Recorders and Reproducers
- Optical Sound Track Recorders
- Interlock Motor Systems
- Projectors
- Consoles
- Electronic Counters

The following summarizes how these various equipments relate to the audio recording process in motion picture production.

## Production Recorders

Today, this equipment generally consists of a 1/4" audio tape recorder equipped with a sync record head. A 60 Hz signal (50 Hz for certain overseas areas) which is laid down during original recording serves as the control track for synchronous playback.

## Transfer Systems

After recording the original dialog on 1/4" tape, "OK" takes are transferred from the 1/4" sync tape to sprocketed magnetic film—either 35mm or 16mm. Transfer systems consist of 1/4" tape reproducers equipped with servo-driven capstans and sprocketed magnetic film recorders—35mm or 16mm.

"Loop boxes" used in the dubbing system hold up to 250 feet of looped film.

These cartridge tapes containing pre-recorded sound effects are not integrated into the overall distribution system, but can be actuated from the master mixing console.

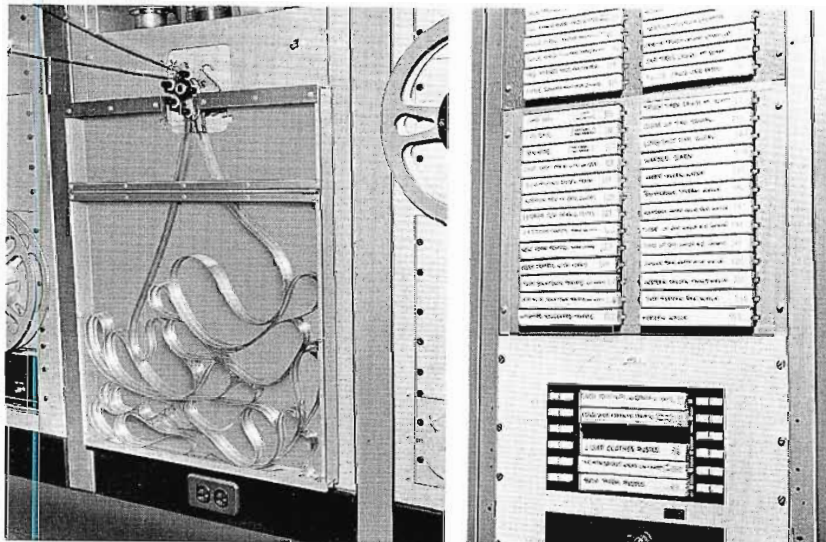

## Scoring

Music scoring stages for motion pictures are similar to stages used by recording companies. In this instance, however, the music score follows the action or theme of the picture. To assure the proper tempo and match, the picture is projected on a large screen so the conductor can musically match the picture content. Recordings are made on sprocketed magnetic recorders on one-inch or two-inch non-sprocketed tape recorders. Since each recorded sequence requires playback for previewing the quality of the program, frame-to-frame synchronization is required between the picture (on the projector) and the 35mm magnetic film. Accordingly, both the projector and the magnetic film recorder are equipped with "Selsyn" interlock motors which in turn are driven by a master interlock motor drive system.

## Effects

Most pictures are shot in short sequences with little attention given to recording anything but the original dialog. After the picture has been edited, special sound effects are then recorded and many are taken from an "effects" library—stored on 1/4" tape. For some unusual effects, separate recordings are made on stages designed specifically for this purpose.

## Looping or Post-Synchronization

The background and outdoor noise at many shooting locations makes it impractical to record usable dialog track. In these situations, the original dialog recording—noise and all—is transferred to 35mm magnetic film. This sound track is then conformed by the editor with the picture. New dialog is then recorded on a special "looping" or "ADR" (Automatic Dialog Replacement) stage. Here, the edited dialog sound track is loaded on a magnetic film reproducer and the edited picture print is loaded on the projector. A special electronic programmable counter allows the director to cue up the magnetic film and picture to a pre-set footage, shuttle both elements between "Start"/"Stop" footages, provide cue tracks to the actor by which to rehearse, and to record replacement dialog tracks.

## Dubbing or Re-recording

Once all sound track elements have been assembled (music, effects and dialog), the next step is dubbing or re-recording. This is the process covered in the accompanying description of the TBS "Dubbing Five" studio.

## Magnetic Film Recorder/Reproducer

The sprocketed magnetic recorder/reproducer may have single track, dual track, three track, four track or six track capability. All recorders are equipped with an erase head, a record/playback head and a monitor head. RCA systems include an 80 kHz Crystal-Controlled Oscillator. Each record amplifier (one for each track) includes a bias amplifier and the bias signal loops through each record amplifier. A separate erase driver amplifier is used for erasure—the bias signal again looping through each erase amplifier. A separate playback amplifier for each track provides monitoring from the monitor head during the record sequence. This automatically switches to the record/playback head during playback in order to maintain synchronism with the picture if the recorder is interlocked to the projector. A combination sync/interlock motor is usually supplied with this system so that the recorder can be operated as stand-alone and locked-to-line—or, it may be interlocked to other equipments.

### Magnetic Film Reproducer

This system is similar to the recorder/reproducer, but without recording capability. Again, such systems can be equipped for playback of single track, two track, three track, four track or six track.

### Interlock or Selsyn Distributor System

To assure frame-to-frame synchronization of picture and multiple sound track elements, each sprocketed magnetic system and the projector is equipped with "Selsyn" interlock motors. A master distributor—which consists of a synchronous motor and a relatively large frame interlock motor—can drive each slave Selsyn motor from standstill to sync speed and back to standstill without losing synchronization. The interlock systems today provide forward/reverse operation at normal sync speed and, in some newer systems, up to 6X sync speed.

### Optical Recording

When the master magnetic soundtrack recording is completed, the next step in the process is to record the photographic sound track, using an optical recording system. The RCA Optical Recording System (Type PM-80B) is comprised of a variable area optical (photographic) recorder; a special amplifier system, and control functions. The mirror of the galvanometer in the optical system vibrates at the frequency of the applied audio signal. The mirror in turn reflects a beam of light across a very narrow slit. An image of the slit is projected to the film at the sound drum to expose the film and, essentially, it takes a picture of a modulated light source at the slit. The amplifier system includes high and low pass filters, a film loss equalizer, a record amplifier and a GNR (noise reduction) amplifier. The noise reduction amplifier provides a dc signal which is inversely proportional to the audio recording signal. This dc signal is applied to a special winding of the galvanometer to deflect the galvanometer mirror—and therefore the light image—at the slit, in such a manner that the sound track becomes almost opaque with no signal.

□

Master footage display for TBS system is located behind the mixing console, along with patch panels and other controls.

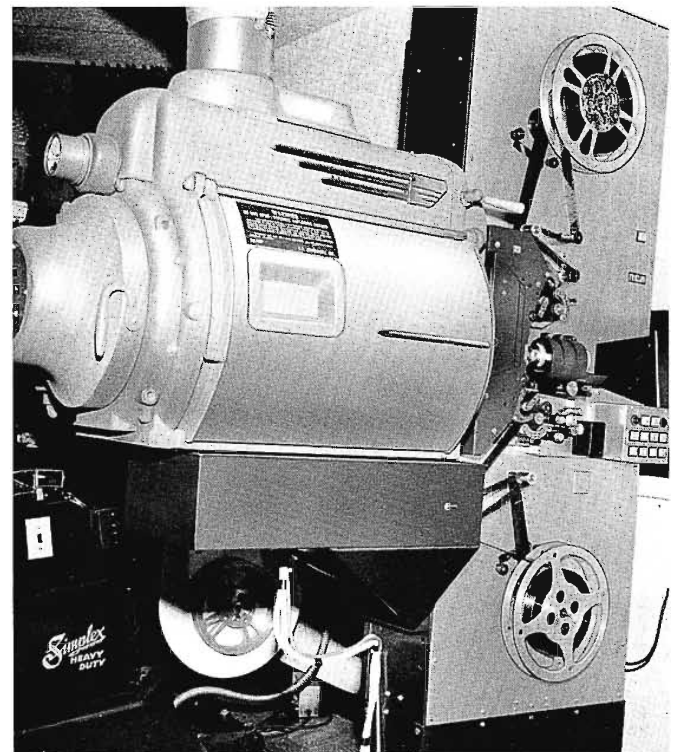

FR-35, servo-controlled 35mm projector is located in projection booth, with control usually delegated to the mixing console. The high speed shuttling capability of the projector saves re-recording time.





TBS' Dubbing Five re-recording stage from behind the mixing console. Display panel beneath screen is a footage counter.

# SIMULATION OF UNATTENDED OPERATION OF UHF-TV TRANSMITTERS

T. M. GLUYAS, Staff Engineer  
RCA Broadcast Systems

**D**URING September, October and November 1974, an interesting experiment was performed at WNJT-TV, Trenton, N. J. The experiment was a 39-day simulation of unattended operation of an automatic transmission system. The test provided useful information to the FCC who then were, and still are, considering rules for automatic and unattended transmitter operation.

Although this type of operation had been considered by the FCC and the broadcast industry off-and-on since 1967, interest has become more intense within the last two or three years. Events during this period, closely related to the WNJT-TV experiment were as follows:

## **Recent History of Automatic TV Transmission**

Early in 1974, the FCC expressed an intention of rule making to permit unattended operation of TV and Aural Broadcast stations. The words "unattended operation" in this case mean that no licensed operator will be required in attendance either at the transmitter or at a remote control location.

To provide some practical knowledge and experience on unattended operation, this operating mode was simulated in a test at KDKA-TV, Pittsburgh, Pa., during February 1974. The test, a joint effort by the Westinghouse Broadcasting Co. and RCA, was described in a paper, read at the March 1974 NAB Engineering Conference, entitled *TV Transmitting Systems for Unattended Operation*. The same paper appeared in *BROADCAST NEWS*, Vol. 154.

The FCC acknowledged the contribution of the KDKA VHF-TV experiment toward unattended operation and expressed a hope that similar experience

could be gained at a UHF-TV station. In response to this, John T. Wilner, Director of Engineering, State of New Jersey Public Broadcasting Authority, made their facilities available for an extended test at WNJT-TV. The test was a joint effort by the N. J. Public Broadcasting Authority and RCA.

Later, on April 14, 1975, the FCC issued a notice of inquiry on automatic transmission systems at AM, FM and TV broadcast stations in which unattended operation was an important item of inquiry. Replies to the FCC notice of inquiry were made by the NAB, EIA, other industry organizations and by individual broadcast stations. The FCC, having considered these replies, is currently drafting proposed rules for the operation of automatic transmission systems. We hope that the WNJT experiment described herein made a worthwhile contribution to their current effort.

## **The WNJT-TV Experiment**

The WNJT UHF-TV experiment was not just a duplication of the KDKA VHF-TV experiment to gain additional experience on automatic transmitter operation. It was longer in duration, more extensive in scope, and the basic equipment configuration differed in important ways—thereby providing experience with a different system arrangement. Some of the differences are as follows:

The KDKA experiment employed automatic control of modulation levels based on a network VIR signal, or inserted VIR when the network signal was absent. The WNJT-TV experiment utilized inserted VIR for the first half of the experiment (no program related VIR was available in the Public Broadcasting Service); but, for the last half

of the experiment an inserted VIT signal was used for automatic modulation level control.

The KDKA experiment involved automatic control of parallel transmitters (an RCA TT-30FL). The WNJT experiment involved automatic control of a transmitter with a common exciter and parallel klystron output amplifiers (an RCA; 60 kW, TTU-60B).

The WNJT experiment included recording the following parameters in addition to power output stability, modulation levels, carrier frequency stabilities and other critical parameters recorded in the KDKA experiment:

1. Weekly record of transmitter sideband response.
2. Daily measurement of differential gain.
3. Daily measurement of differential phase.
4. Log every 3 hours of intercarrier frequency stability (in addition to visual and aural frequency stability).
5. Log, at 3 hour intervals, magnitude of automatic video correction of six parameters vs. three for KDKA.
6. Record of klystron collector voltage stability.

The duration of the WNJT test was 39 days. Altogether some 3500 data points were manually logged and plotted.

In the WNJT-TV simulation of unattended operation the transmitter was attended, as required by the current rules, but operators were instructed to keep "hands-off" the operating controls (except the On-Off control).



TTU-60B, 60 kW UHF Transmitter used for WNJT-TV test of unattended operation.

All maintenance and adjustments were carried out on a scheduled basis—at approximately weekly intervals. One component failure during the 39 day period required unscheduled maintenance but this was done during non-broadcast hours and did not affect the continuity of the test.

A special supplementary log was created for the tests to expand the list of normally logged parameters. Altogether, 14 parameters were logged; each logged at the start of the broadcast day and at three hour intervals during the day.

VIR and VIT signals were inserted at Studio Master Control in Trenton, N. J., approximately 4½ miles from the transmitter location, by means of a Tektronix model 147 NTSC Signal Generator. The studio-to-transmitter link is microwave. Fig. 1 shows the transmitter plant system arrangement.

#### VIR or VIT Signals Employed for Automatic Control of Modulation Levels

A VIR signal inserted on line 20 was employed during the first 21 days of the test for automatic control of modulation levels and a VIT composite test signal inserted on line 19 was employed during the last 18 days of the test.<sup>1</sup> These waveforms, and the sampling

intervals selected for automatic modulation level control, are shown in Fig. 2.

A Tektronix Model 1440 Automatic Video Corrector, fed from a Rohde & Schwarz AMF visual demodulator, was connected around the transmitter in a closed loop mode, as shown in Fig. 1. This arrangement automatically regulated transmitter depth of modulation, sync level, setup, burst amplitude, burst phase and chrominance/luminance ratio using the VIR signal as a reference.

During the last 18 days of the test, the VIT reference white signal controlled the transmitter modulation level by means of a modified Tektronix 1460 Automatic Video Corrector substituted in place of the Model 1440. The Model 1460 was designed by Tektronix for the European ITS signal, which resembles the U.S. VIT signal. A developmental model 1460 was modified by Tektronix especially for the WNJT tests and loaned to RCA and WNJT for the tests to be described.

On Sundays, during the tests, one two-hour program was an off-air pick-up at the transmitter site for a rebroadcast of a NET program from channel 12, WHYY-TV. Since the VIR inserter is at Master Control, this program did not include a VIR or VIT signal. The

Tektronix model 1440 Automatic Video Corrector automatically reverted to a preset mode for this program and the absence of VIR was logged by the operator. Although the system performance was very good, this one broadcast segment (just one dot per week on each data plot) was not included in the data plots because a fully implemented automatic system would have the VIR control signal present at all times. Also, the initial ID each day is from slide and audio cartridge tape at the transmitter site and does not include VIR or VIT signals. The automatic video corrector reverts to preset mode for the initial ID. This lasts less than one minute, after which the transmitter is immediately switched to Trenton Master Control and automatic video correction for the balance of the broadcast day.

Fig. 3 shows the preset control panel directly below the Model 1440 Automatic Video Corrector. Below that is a meter panel which displays how much signal correction is being applied by the 1440 in the automatic mode for each of six controlled parameters. These values were recorded and plotted, and are discussed later.

<sup>1</sup> Present FCC rules now reserve line 19 for the VIR signal. VIT signals now are inserted on lines 17, 18.

### Transmitter Modifications and Additions for Unattended Operation

Refer once again to the simplified block diagram of the WNJT-TV visual transmitter connected for unattended operation as shown in Fig. 1. The transmitter output is sampled with a directional coupler in the transmission line at the combined klystron output and the RF sample is connected to a modified "backporch" feedback clamp circuit in the TTUE-4A exciter. The feedback clamp circuit was added to the exciter specifically for the test of unattended operation. It holds the pedestal level power constant at the output of the transmitter.

A second directional coupler at the filterplexer output provides a signal for the Rohde & Schwarz AMF demodulator which is connected to a Tektronix 1440 in series with the transmitter video input. This arrangement is another overall feedback loop and it maintains, among other things, the various modulation levels in correct *proportion* to each other. Since the correct pedestal level power is established by the first loop, and the correct sync-to-pedestal level ratio is established by the second loop, it follows that the sync peak power at the transmitter output is held at a constant level.

The automatic pedestal level control that was added to the TTU-60B for the test, deserves some further comment. Fig. 4 is a block diagram of the system with emphasis on the details of the exciter. The added and modified portions of the system are outlined by dashed lines in Fig. 4.

A plug-in feedback clamp circuit board in the standard exciter was replaced by a new board which includes a control limiter. The new board includes a switch to select between internal clamp—the normal mode—and external clamp which provides overall transmitter feedback for stabilizing transmitter pedestal level power output. A pedestal level bias connection to the detector is shown in the diagram. This provides a capability for adjusting pedestal level DC voltage at the output of the detector so that there is no change in transmitter power when switching between "internal" and "external" clamp modes at the beginning of an unattended operating period. In other words, it centers the range of automatic power control for zero error signal at the start of an unattended period of operation.

The function of the "control limiter" circuit on the new plug-in board is to

enable the transmitter to turn on smoothly without additional control circuit logic. Without this circuit, during the turn-on risetime of power output, the feedback loop would call for full, normal, power output, and perhaps drive the modulator, low level IF, or RF amplifier into saturation or cause the transmitter to trip-off. This is prevented by limiting the range of automatic control in the increased-power-output direction.

### Aural Power Output Control

The unattended simulation purposely omitted automatic control of aural power. UHF-TV transmitters employing klystrons usually have automatic regulation of primary power to  $\pm 1\%$  of line voltage. Because of this and other factors, UHF-TV transmitters have developed a reputation for stable power output. The aural transmitter has a potential of greater power stability than the visual transmitter since there are fewer circuits that affect power output and the stages, including the klystron output amplifier, can be operated closer to saturated power. We wanted to see if the aural transmitter required any automatic control for long term stable operation at normal power. Our conclusion based on the test is given in later paragraphs.

### Purpose of Test Data

A practical unattended transmitter system is expected to have precise and stable automatic control of power output and modulation levels. It is expected to have long term stable performance of carrier frequency, sideband response, differential gain, differential phase, and other parameters, without a need for automatic correction of these parameters. To determine if these expectations were realized, data was logged every three hours for 39 days and plotted in the charts to be discussed next. Other parameters were measured and recorded once each day.

### Visual Power Output Stability

Fig. 5 shows the transmitter system power output stability.

The transmitter was scheduled for maintenance and adjustment on Monday evenings or, more precisely, Tuesday mornings—since the transmitter programs ended at roughly midnight. As may be noted in Fig. 5, the Monday, October 15 maintenance and adjustment session was postponed to October 17 to coincide with the availability of the Tektronix modified 1460 controller, to be substituted for the 1440 as discussed in a previous section. Also, note that on October 8, no main-

tenance or adjustment was made. The data taken that evening indicated that no adjustment was necessary or desirable. The transmitter was operated from Sept. 30 until Oct. 17 with no manual control or adjustment. The visual power output was stable within a power range of 8% between adjustments—compared to an FCC tolerance of 30% (+10%, -20%). Except for a few isolated points, the power stability between adjustments remained within 5%.

The visual power plot points up a difficulty that was experienced in setting the power at precisely 100% during the scheduled maintenance and adjustment session. The adjustable component was a small screw driver control with too much sensitivity. This can easily be improved in a product design.

### Aural Power Output Stability

Both visual and aural power output stabilities are included in Fig. 5.

Although the aural power remained within acceptable limits, the power variation was greater than expected—based on impressions of performance of other UHF-TV stations. However, no comparable *data* exists on the stability at other stations.

Perhaps it is a good thing that the power varied significantly during this test. Otherwise, it might have led to an unwarranted conclusion that no aural automatic power control is desirable.

An unattended station should be forgiving of poor or wornout components, loose connections and other things that might cause the power to wander. We conclude that automatic control of aural power is desirable, not only to reduce power output variations but also to extend intervals between scheduled and unscheduled maintenance. It is intended that automatic aural power control will be made available for RCA UHF-TV transmitters at a future date.

The 10% aural power change on October 19-20 (Fig. 5) is related to the only non-scheduled maintenance during the test. On that date, a resistor in the klystron modulating anode power supply was replaced. It had been damaged by klystron gas arcs. Before the test, visual klystron #2 had a history of occasional gas arcs. However, it otherwise performed well and it was decided not to retire it from service. Gas arcs in visual #2 klystron continued during the test, and on occasion, the klystron modulating anode shorted to ground. These faults did not interrupt serv-

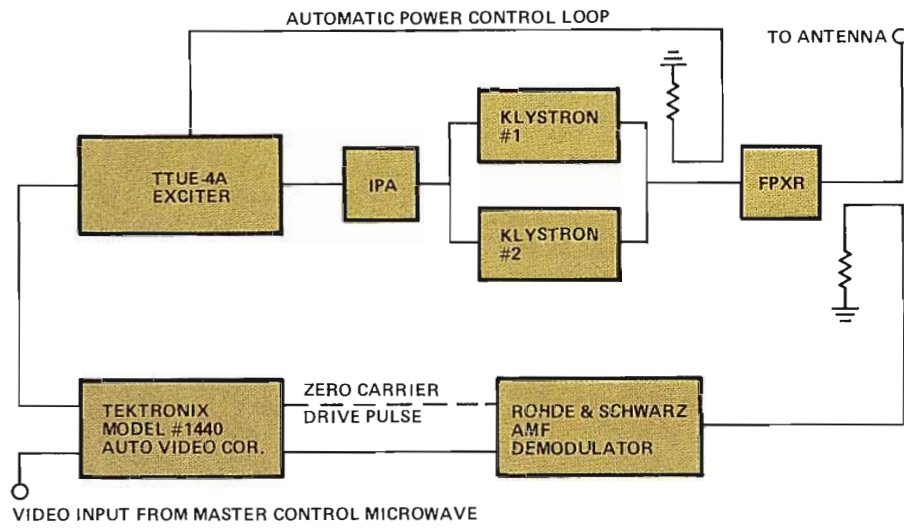

Fig. 1 Block diagram. Transmitter system employed for simulated unattended operation.

Fig. 2 VIR (left) and VIT (right) signals referenced by the automatic modulation level control system.

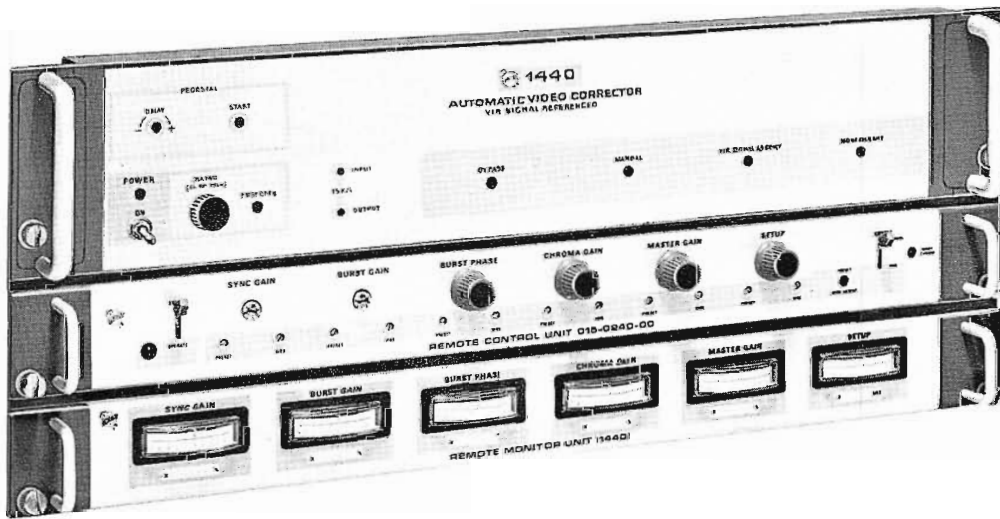
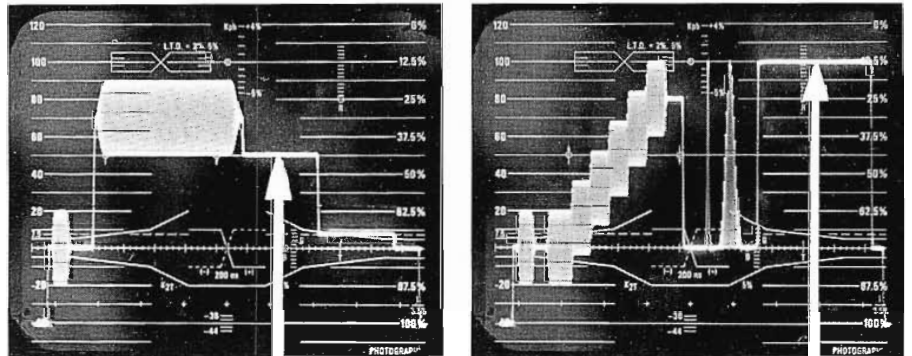

Fig. 3 Tektronix 1440 Automatic Video Corrector with preset control panel and meter panel.

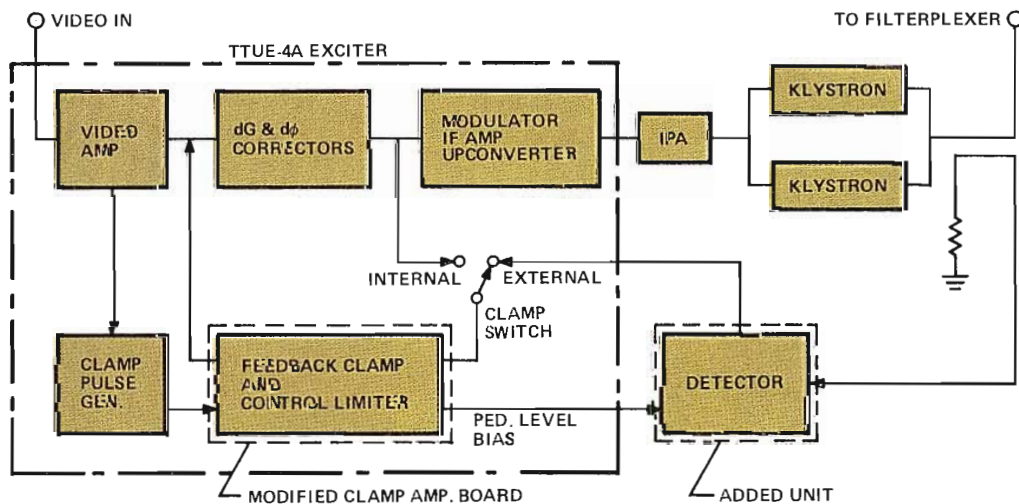

Fig. 4 Block diagram showing overall feedback clamp for stabilizing pedestal level power output.

Fig. 5  
WNJT-TV POWER OUTPUT STABILITY

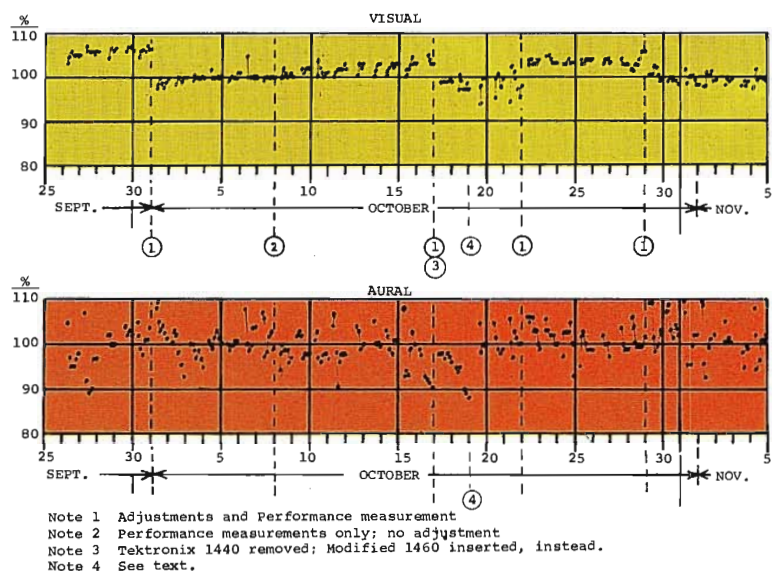

Fig. 6

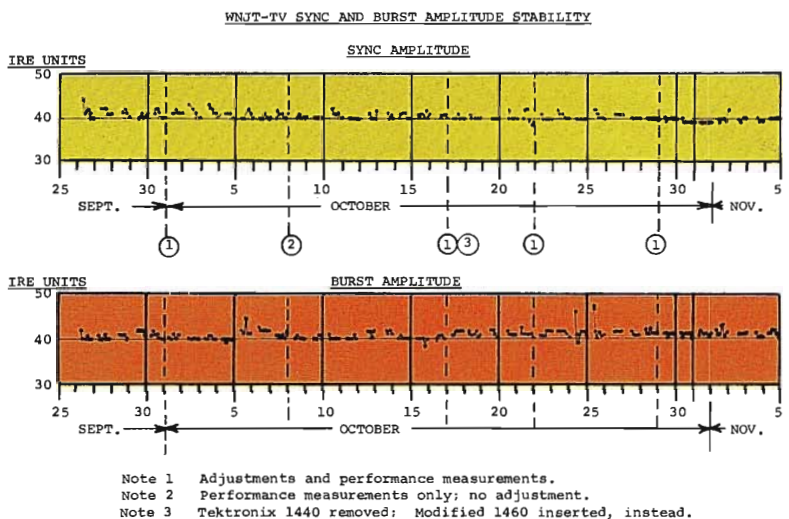
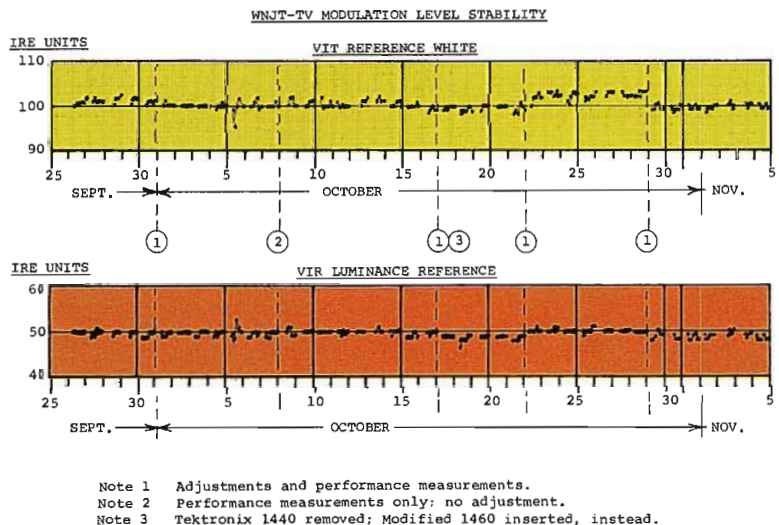

Fig. 7



ice or noticeably affect performance. However, they produced changes in the aural klystron current because all three klystrons share a common mod. anode voltage divider circuit. Since there is no automatic aural power output control circuit, the fault adversely affected aural output stability.

**Stability of Modulation Levels**

The stability of sync amplitude, burst amplitude, VIR luminance reference, and VIT reference white (depth of modulation) all remained more stable throughout the test than likely could have been maintained by manual operation. Most of the readings are within oscilloscope reading tolerance—when allowing for parallax and differences among the several operators.

Sync amplitude stability is shown in Fig. 6. All readings are within  $\pm 2$ ,  $-1$  IRE units of the standard level except on three occasions when the transmitter came on, at the beginning of the broadcast day, at  $+3$  IRE units, then promptly drifted to within the close tolerances just mentioned.

Burst amplitude remained within  $\pm 2$  IRE units except for four or five isolated readings. All but one of these was the first reading at the start of a broadcast day.

Fig. 7 shows the stability of depth of modulation (VIT reference white) and the stability of the VIR luminance reference. Except for one isolated reading on Oct. 5, (out of a total of 226 readings), the VIT reference white remained within 2 or 3 IRE units of its initially set value until the next scheduled adjustment. The FCC tolerance on modulation depth is  $12\frac{1}{2}\% \pm 2\frac{1}{2}\%$  of sync peak. This translates to  $100 \pm 4$  IRE units. We conclude that stability of modulation depth is completely satisfactory. It is about 2/1 better than experienced during a similar VHF-TV test on a parallel transmitter (TT-30FL) at KDKA during Feb. 1974.

It is worth noting that the control of depth of modulation was equally good whether the VIR signal was used as a reference (Sept. 26-Oct. 16) or the composite VIT was used as a reference (Oct. 17-Nov. 5).

The VIR luminance referenced remained at the correct value of 50 IRE  $\pm 2$  IRE units throughout the test—except for two isolated readings. The luminance reference stability was completely satisfactory.

Several of the parameters just discussed, specifically sync amplitude, burst

amplitude, visual depth of modulation, VIR luminance reference, and indirectly, visual power output are stabilized by overall feedback around the transmitter. In contrast, the stability of differential gain, differential phase, visual carrier frequency, aural carrier frequency, and visual transmitter side-band response, to be discussed next depend on the basic transmitter circuit design without benefit of overall feedback control loops.

### Stability of Technical Performance

Differential gain and differential phase were measured daily, using a 10 riser VIT stairstep signal. It was not a standard transmitter test signal. The luminance axis of the brightest step was at 100 IRE units which places the tips of the 3.58 MHz signal at 110 IRE units. This is deeper modulation than called for in EIA standard RS-240. The results are plotted as dots in Fig. 8. These measurements were supplemented by measurements made during the scheduled maintenance sessions using a 5 riser stairstep with the peak of the subcarrier of the brightest step just reaching 100 IRE units. The data from the latter measurements are plotted as "X" marks in Fig. 8. The "X" marks on adjacent days at the scheduled maintenance periods show the result at the end of one period followed by a readjustment to start the next period. It indicates a readjustment and *not* a one day drift.

The differential phase remained within 3° except that on one day only, October 29, it reached 4° at the close of the broadcast day. This is considered satisfactory but it probably will be improved as an incidental consequence of planned improvement in differential gain stability to be discussed next.

Differential gain, also shown in Fig. 8, remained well within the system tolerance implied by the FCC rules, but only marginally within the TTU-60B transmitter published specification.

Differential gain was adversely affected by the automatic power control circuit, added for the test. Consequently, it is planned to employ a different and improved external feedback clamp circuit design for the final product instead of the circuit improvised for the WNJT-TV experiment.

Visual carrier, aural carrier, and intercarrier frequency stability plots are shown in Figs. 9 and 10. The results are entirely satisfactory. There is an indication of perhaps 200 Hz warmup drift immediately after turn on at the start of the broadcast day. Otherwise, aural

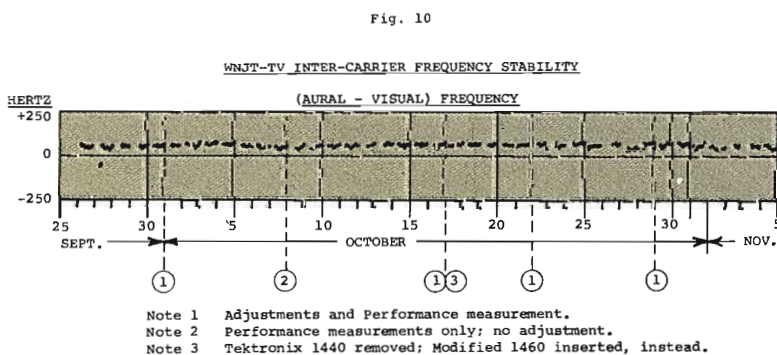
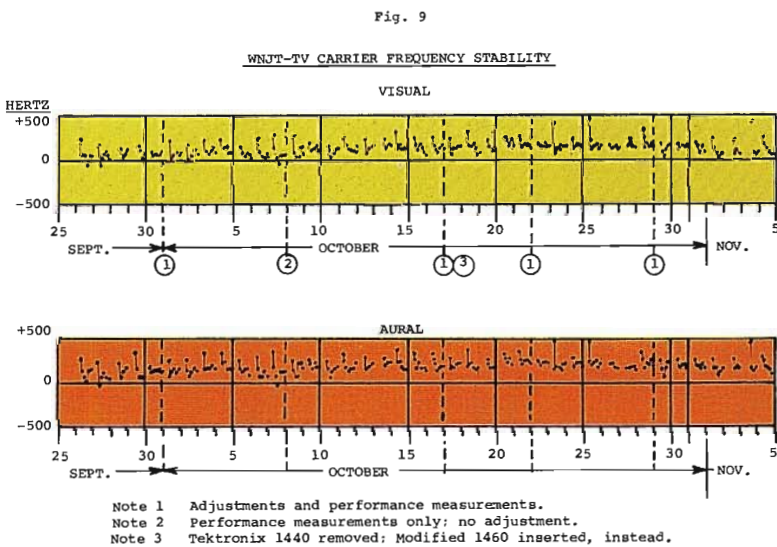
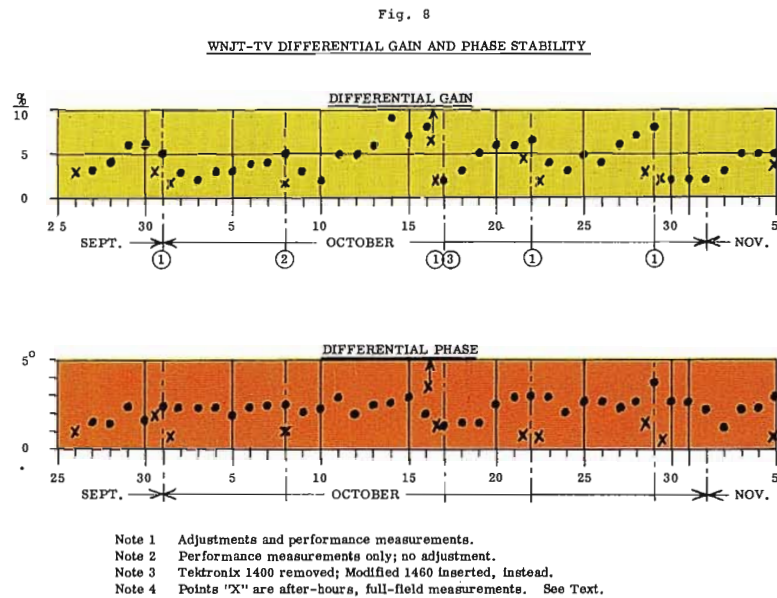

and visual carrier frequencies were stable within 250 Hz throughout the 39 day test period. Inter-carrier frequency stability remained within approximately 40 Hz.

Sideband response stability may be evaluated from inspection of Fig. 13. Photos A and B show the stability during the first week. There is no observable change. At the first scheduled maintenance session, September 30, the response was readjusted to obtain a flatter, more normal, response (Photo C). After that, the response was not realigned for the duration of the test (Photos C-H). It remains quite constant.

The maximum change in sideband response throughout the 39 day period was  $\pm 0.3$ ,  $-0.4$  dB. This is completely satisfactory. It is believed that the actual RF circuits stabilities are better than this. The overall feedback loop that maintains constant power output causes various small shifts in RF level and circuit loading throughout the exciter, IPA and output klystron. These changes, rather than basic circuit stability, probably account for the small, and acceptable, change observed in the sideband response.

#### Automatic Video Corrector Error Signals

The Tektronix 1440 automatic video corrector, employed in closed loop transmitter control, maintains the modulation levels constant at the transmitter output as previously discussed. Error signals in the several control circuits of the Tektronix 1440 are read on six meters on a monitoring panel. Four of the six error signals were plotted. In effect, these metered signals indicate what the transmitting system performance would have been *without* automatic control.

It should be understood that the indicated error signals (amount of correction) is the correction required and applied for the *entire system*—not just the transmitter. The automatic operation establishes the correct level at the transmitter output and therefore, for some signal parameters, it is correcting for studio equipments, manual adjustment errors at studio or master control, studio-transmitter microwave drift, and main transmitter drift.

Fig. 11 shows the amount of automatic correction applied to composite video gain (master gain) and sync gain (sync-to-picture ratio). Although the automatic video gain correction was modest—generally under 5% and seldom exceeding 10%—nevertheless it is apparent that VIT reference white

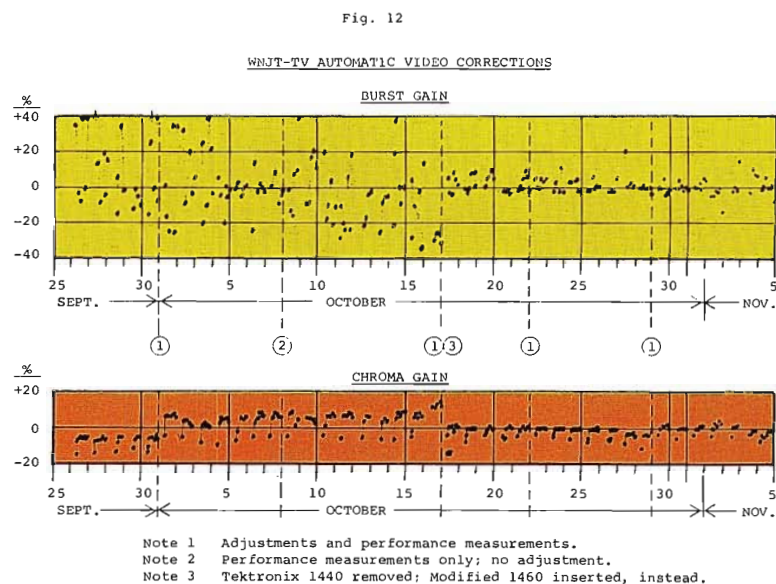
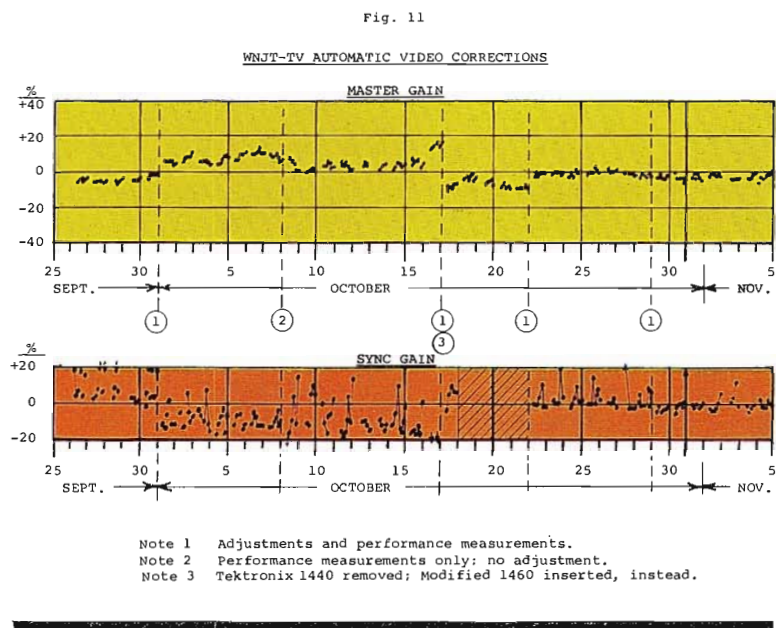

level would not have remained within FCC limits without manual operation or automatic control.

There is some question about the amount of sync gain correction (Fig. 11) and also the burst gain correction (Fig. 12). There is no apparent reason why the amount of system correction needed and applied before October 17 should have been any greater than after October 17 at which time the modified Model 1460 corrector was substituted for the Model 1440 corrector. The correctors contain two adjustments to calibrate each of the six meters. Perhaps these were incorrectly set for sync. and burst meter calibrations, either before or after October 17. In any case, it is apparent that the automatic corrector is essential for satisfactory system operation in an unattended mode.

The break in sync gain data (Fig. 11) October 17-22 was due to an open coil in the Model 1460 corrector. The corrector had been modified by Tektronix on an expedited basis for the WNJT-TV test.

Sync gain and burst gain automatic corrections correct for a long chain of equipments; perhaps from an original camera or tape source, depending upon whether or not there are intermediate stabilizing amplifiers that regenerate sync and burst levels. On the other hand, chroma gain correction (Fig. 12) operates on VIR information and consequently corrects only for performance drift between the point of VIR insertion (i.e. WNJT Master Control in Trenton, N.J.) and transmitter output (4½ miles away). Except for what may be a small warm-up drift, the chroma gain correction does not



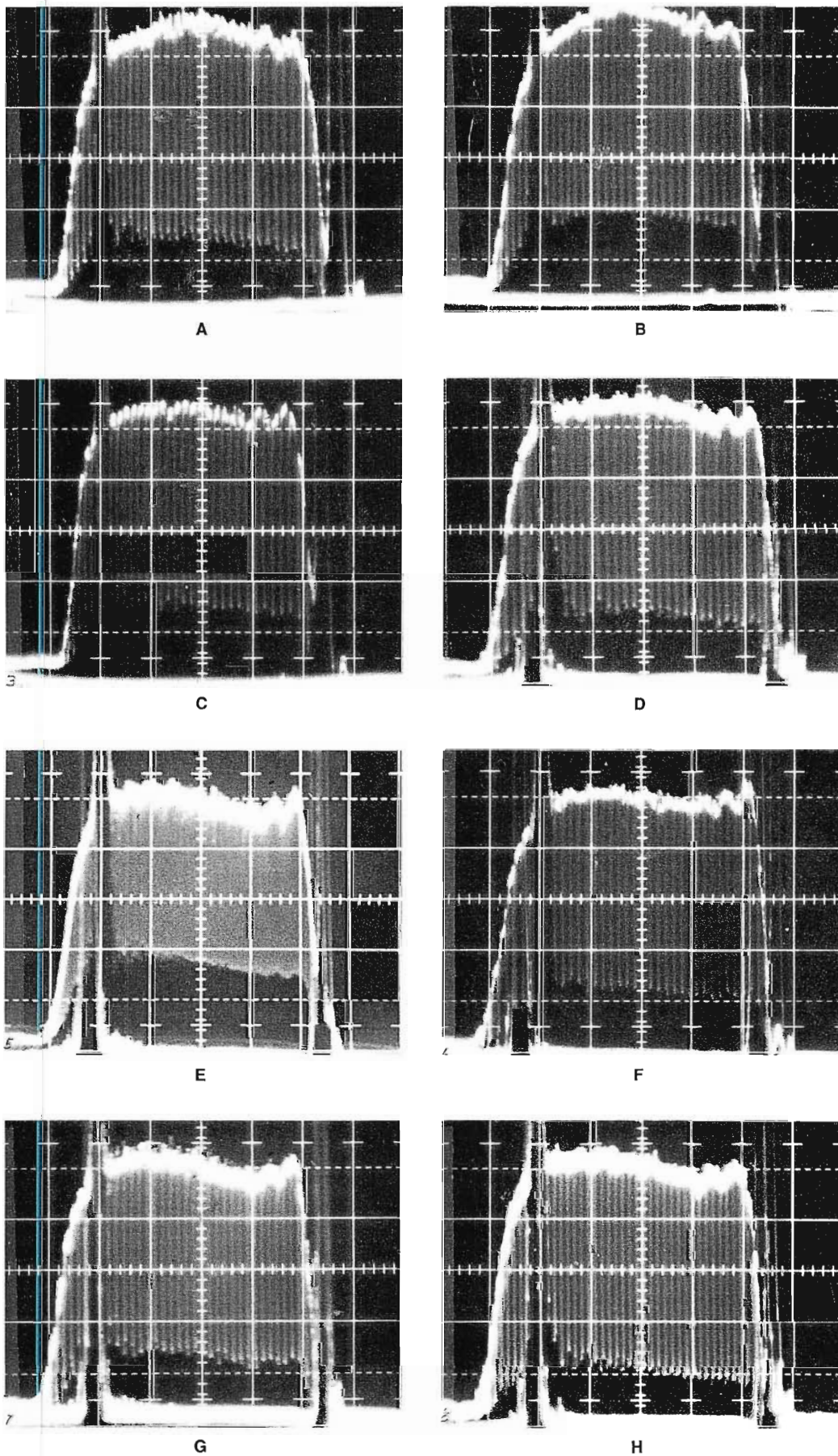

Fig. 13 Sideband response stability. Klystron tuned on Sept. 30. No other adjustment.

exceed  $\pm 5\%$  between scheduled maintenance and adjustment sessions. Basically, this shows that the transmitting system frequency response (including auxiliary and microwave) is quite stable even without automatic correction.

### Conclusion

The 39 day simulation of unattended operation at WNJT-TV demonstrated that unattended operation of a current generation UHF-TV transmitter is practical. Automatic control of both visual and aural power output is indicated as the most desirable way of achieving satisfactory long term power output stability—especially in the event of circuit irregularities and/or component wearout.

When using overall feedback from transmitter output to an automatic video corrector at the transmitter input (Tektronix Model 1440), all visual modulation levels were closely held to the correct values. It seems likely that the automatic control maintained the modulation levels with greater precision than would have been maintained by manual operation.

The depth of modulation stability (VIT reference white) and the visual power output stability in the UHF-TV test at WNJT exceeded the performance attained in a similar VHF-TV test at KDKA some eight months earlier. Other performance parameters were about equally satisfactory in the UHF or in the VHF tests. It would seem that it is no more difficult to accomplish satisfactory unattended operation of a UHF than a VHF TV transmitter.

### Disclaimer

Use of the WNJT-TV facility and the wholehearted effort of the management and staff to determine the feasibility of automatic transmission system operation does not necessarily constitute an endorsement by the New Jersey Public Broadcasting Authority of the concept of transmitter operation without a licensed operator in attendance.

### Acknowledgement

The automatic transmission system tests were made possible by John T. Wilner, Director of Engineering, State of New Jersey Public Broadcasting Authority who made the complete facilities of WNJT-TV available for the experiment.

Special thanks go to Larry H. Will, transmitter supervisor, for his enthusiastic effort and to his staff, Larry Efaw and Dudley Bullock who made the system modifications and carried out the various tests.

Thanks are extended to C. W. Rhodes and Steve Kerman of Tektronix who provided the Model 1440 and modified 1460 Automatic Video Correctors employed in the system for the experiment. □





### Meanwhile, back at the studio...

Place the TKP-45 on a tripod or pedestal, and—presto!—it's a full-capability studio camera. Indoors or out, you can use fixed optics (teles, wide-angles, fish eyes), or zooms through 34:1 ratio; the choice is yours.

Pick a 3" or 7" viewfinder—no compromise to camera size in the viewing department. Let the TKP-45 perform beside a TK-44 or TK-45, then try to tell the difference. A full range of automatic controls and video performance features says you can't!

### For proof, ask MTS.

MTS, Mobile Television Services, is a teleproduction company on the move—to the tune of 20,000 miles in its first four months. This unique firm operates a 40-foot mobile unit that houses more than a million dollars' worth of broadcast television gear. The equipment, equal to many a commercial broadcast station, includes:

- 5—TK-45A color cameras with joystick controls
- 1—TKP-45 portable color camera
- 2—TR-61 video tape recorders
- 2—Slo-Mo video tape recorders



Custom audio and video switching systems

MTS began in mid-1974 as the production company for the World Football League's "Game of the Week". The first season involved 20 games, including WFL action and bowl games, the Miss World Pageant, several "Wide World of Entertainment" segments for ABC, and the new show, "Almost Anything Goes."

### TKP-45 gets the action.

Right from the start, the TKP-45 played an integral part in every production. At



### TKP-45 UNIVERSAL CAMERA SYSTEM

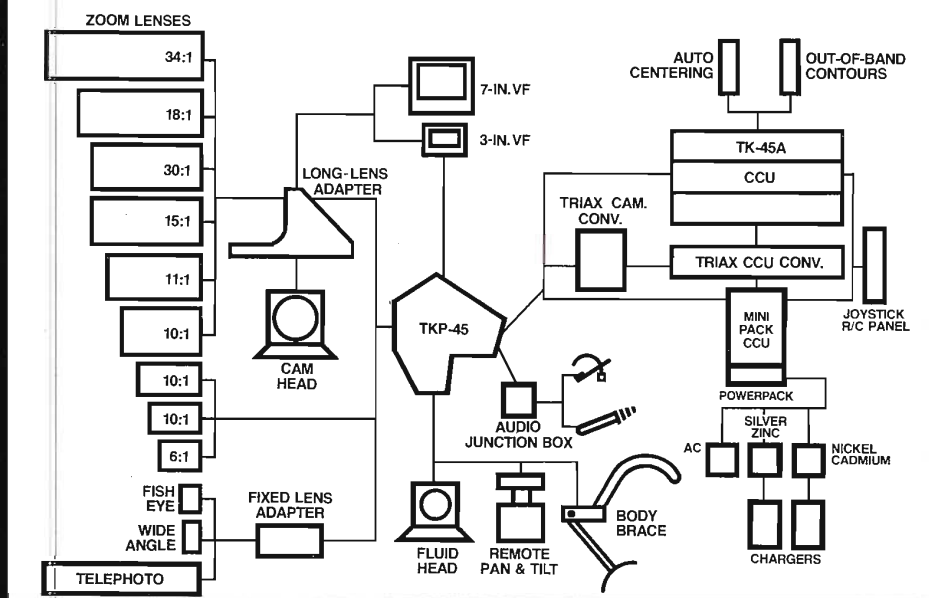

We'd welcome the chance to pit the TKP-45 against any newsgathering or studio cameras to prove that "you can't beat The System" for quality and features at an attractive price.



the sports events, it is used to capture action scenes and impromptu interviews, with all the picture quality of its TK-45 companions. And it adds tremendously to MTS' in-studio productions.

Quality is the MTS cornerstone. "You're only as good as your last job," says MTS Executive Vice President Howard Zuckerman. "Every assignment must be done right, without skimping or corner-cutting."

It's no coincidence that MTS picked the TKP-45 to add the final touch to its RCA camera lineup.

**RCA**

